

## SPECIFICATION SHEET

**T3145DG**

3-1/2" Series – Classic/Evolution

**Low Profile Square Double Gimbal Trim**

Project \_\_\_\_\_

Notes \_\_\_\_\_

Fixture Type \_\_\_\_\_

Date \_\_\_\_\_

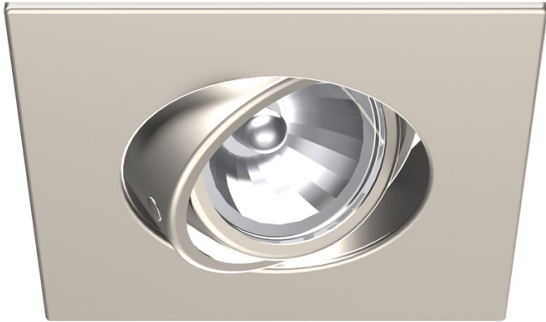
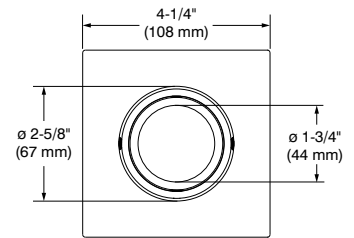
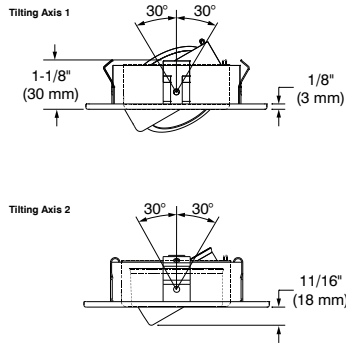
T3145DG-13 (illustrated)  
(Lamp not included)

## SPECIFICATIONS

TRIM	Die-formed steel.
<i>Options in red may generate a longer production lead time</i>	<b>Different finishes available:</b> <b>Powder coat painted (Standard)</b> White (-01), Black (-02), Architectural Bronze (-05), Antique Cooper (-06), Matte White (-11), Matte Black (-22) and Polar Grey (-25) <b>Plated (Premium)</b> 24K Gold Plated (-03), Chrome (-04), Brushed Chrome (-04BR), Brushed Nickel (-12BR) and Satin Nickel (-13)
LAMPS (not included)	<b>GU10 LED 10W MAX</b> <b>MR16 GU5.3 37W MAX</b> (Remodel and Insulated housing) (protected lamps only) <b>MR16 LED GU5.3 10W MAX</b> 50W MAX (New Construction housing) (protected lamps only)  If you want to use the dimming option and you use a LED lamp, please refer regularly to the lamp manufacturer compatibility list.  For MR16 LED lamp usage, please refer to the selected housing specification sheet for details on transformer models (see compatible housing list below).
CEILING CUTOUT	<b>ø 3-5/8" (92 mm)</b>
ACCESSORIES	<b>Goof Rings</b> (see ordering code) <b>Choice of optional lenses to customize your lighting:</b> (see ordering codes) <b>Clear (C):</b> <b>Frosted (F)</b> <b>Honeycomb (H):</b> the honeycomb louver reduces glare <b>Linear (L):</b> the linear lens directs the lamps beam to create a strip of light <b>Prismatic (P):</b> the prismatic lens diffuses and spreads the light in an even overall pattern <b>Solite (S):</b> the solite lens softens the light in an even overall pattern  <b>Although not dangerous, the use of a 49 mm lens in conjunction with an LED lamp can result in overheating of the latter, reducing its lifespan.</b> <b>Contrast cannot be held responsible for the overheating of LED lamps used with accessory lenses.</b>
CERTIFICATION	cULus for <b>damp locations</b> (for LED and halogens lamps)
WARRANTY	1 year limited warranty on components against manufacturing defects

**CONTRASTE**

2021-01

PRINTED IN CANADA

1009, rue du Parc Industriel  
Lévis (Québec) G6Z 1C5 Canada  
Tel.: 1-888-839-4624  
Fax.: 1-877-839-7057  
contrastlighting.com  
info@contrastlighting.com© 2021 Contrast Lighting M.L. Inc.  
All rights reserved

Contrast Lighting M.L. Inc. reserves the right to make changes in specifications and/or to discontinue any product at any time without notice or obligation and will not be liable for any consequences resulting from the use of this publication.

SPECIFICATION SHEET

# T3145DG

3-1/2" Series – Classic/Evolution

## Low Profile Square Double Gimbal Trim



SPECIFICATIONS (CONT'D)

COMPATIBLE HOUSINGS

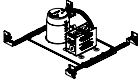
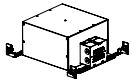
	Remodel Housing 	New Construction Housing 	Insulated Housing 
<b>LED</b> 10W	<b>IC / Air Tight</b> RE35GU10-10W RE35MR16-120-10W RE35MR16-277-10W	<b>IC / Air Tight</b> NW35GU10-10W NW35MR16-120-10W NW35MR16-277-10W	<b>IC / Air Tight</b> IC35GU10-10W IC35MR16-120-10W IC35MR16-277-10W
<b>HALOGENS</b> 37W/50W	<b>Non-IC / Non Air Tight</b> RE35MR16-120-37W RE35MR16-277-37W	<b>Non-IC / Non Air Tight</b> NW35MR16-120-50W NW35MR16-277-50W NW35MR16-120D-50W NW35MR16-277D-50W	<b>IC / Non Air Tight</b> IC35MR16-120-37W IC35MR16-277-37W IC35MR16-120D-37W IC35MR16-277D-37W

CODIFICATION EXAMPLE

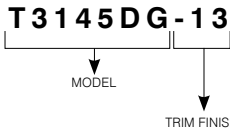

*Options in red may generate a longer production lead time.*

ORDERING CODES

MODEL	TRIM FINISHES
<b>T3145DG</b>	
<b>T3145DG</b>	<b>POWDER COAT PAINTED (Standard)</b>
-01	White
-02	Black
-11	Matte White
-22	Matte Black
-25	Polar Grey
-05	Architectural Bronze
-06	Antique Copper
	<b>PLATED (Premium)</b>
-04BR	Brushed Chrome
-12BR	Brushed Nickel
-03	24K Gold Plated
-04	Chrome
-13	Satin Nickel

GOOF RINGS

Goof rings correct the openings too large or damaged ceiling cutout.

All goof rings are available in all Contraste finishes. Add finish color code at the end of the goof rings code.

Ex.: RON3100-06

**Code: RON3100**

Outside dimensions: 5" (127 mm) x 5" (127 mm)  
Inside diameter: ø 3-5/8" (92 mm)

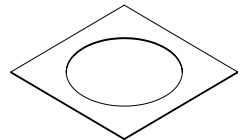

LENSES (49 MM)

For a modification of the light distribution.

- Clear (C): **103104**
- Frosted (F): **304826**
- Honeycomb (H): **103089**
- Linear (L): **103092**
- Prismatic (P): **103095**
- Solite (S): **103098**

