

Classic / Evolution

by / par



CONTRASTE



Contraste is a leading North American manufacturer of quality lighting products delivering superior, lasting value.

We offer a comprehensive range of stylish recessed and pendant luminaires. We are especially well-known for our forgiving installation features and our extensive selection of finishes, providing much appreciated design flexibility to lighting professionals and their customers.

Since 1989, our product line has evolved to comprise several LED luminaire families, a comprehensive line of frames and trims specifically designed for use with LED lamps.

Our development efforts are customer-focused, future-oriented and environment-friendly. We strive to remain relevant by continually improving the energy efficiency, visual appeal and overall lighting performance of our products. See for yourself.

Contraste est un chef de file nord-américain dans la fabrication de produits d'éclairage durables et de qualité supérieure.

L'entreprise propose un vaste éventail de luminaires attrayants qui englobe des modèles encastrés et de suspendus. Nous sommes reconnus particulièrement pour la facilité et la rapidité d'installation de nos produits, et pour notre choix étendu de finis, assurant une grande souplesse de design très appréciée par les professionnels de l'éclairage et leurs clients.

Depuis 1989, notre gamme de produits a beaucoup évolué, et comprend aujourd'hui plusieurs familles de luminaires à DEL.

Nos efforts de développement sont centrés sur le client, orientés vers l'avenir et respectueux de l'environnement. Nous mettons tout en œuvre pour demeurer pertinents aux yeux de nos clients en améliorant continuellement l'efficacité énergétique de nos produits, de même que leur esthétique et leur performance d'éclairage globale.

TABLE OF CONTENTS / TABLE DES MATIÈRES

A WINNING COMBINATION

Contraste has merged two of its largest collections of lighting fixtures.

The Classic line, known for its wide variety of trims offered in a vast choice of colors. Available in 3-1/2" and 4" with GU10, PAR and MR16 source halogen lamps.

And its Evolution line designed for LED lamps with a reduced load. With a large choice of housings designed to fit LED lamps.

The combination of its two major product families offers greater flexibility in the choice of lighting fixtures.

Housings	5
Housings / Trims Compatibility List	14
Trim Index.....	16
3-1/2" Trims	19
4" Trims.....	45
Accessories.....	57

UNE COMBINAISON GAGNANTE

Contraste a fusionné deux de ses grandes collections de luminaires.

La gamme Classique reconnue pour sa grande variété de garnitures offertes dans un vaste choix de couleurs. Disponible en 3-1/2 po et 4 po avec ampoules halogène de source GU10, PAR et MR16.

Et sa gamme Evolution conçu pour les lampes à DEL ayant une charge réduite. Avec un grand choix de boîtiers conçus pour s'adapter aux lampes à DEL.

La combinaison de ces deux grandes familles de produits offre une plus grande flexibilité dans le choix de luminaires.

Boîtiers	5
Liste de compatibilité boîtiers / garnitures	14
Index des garnitures.....	16
Garnitures 3-1/2 po	19
Garnitures 4 po	45
Accessoires.....	57



Trim Finishes / Finis de garnitures

POWER COAT PAINTED / RECOUVREMENT EN POUDRE (Standard)

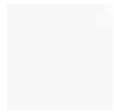

-01
White
Blanc



-02
Black
Noir



-05
Architectural Bronze
Bronze architectural



-06
Antique Copper
Cuivre antique

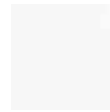

-11
Matte White
Blanc mat



-22
Matte Black
Noir mat



-25
Polar Grey
Gris polaire

PLATED / PLAQUÉ (Premium)



-03
Gold Plated 24K
Plaqué or 24K



-04
Chrome
Chrome



-04BR
Brushed Chrome
Chrome brossé



-12BR
Brushed Nickel
Nickel brossé



-13
Satin Nickel
Nickel satiné

Options in red may result in a longer lead time.

Les options en rouge peuvent générer un délai de production plus long.

Reflectors / Réflecteurs

ANODIZED / ANODISÉ



Standard: Natural Anodized Aluminum
Standard : aluminium anodisé naturel

SPECULAR / SPÉCULAIRE



CL
Clear
Clair



BK
Black
Noir

PAINTED / PEINT



-01
White
Blanc



-02
Black
Noir



-11
Matte White
Blanc mat

Icons / Icônes



LED Lamps
Lampes DEL



Halogen Lamps
Lampes halogènes



Damp Locations
Endroits humides



Wet Locations
Endroits mouillés



Ceiling Cutout
Trou de perçage



120V
277V
Voltage
Tension





Housings Boîtiers

HOUSINGS / BOÎTIERS

New Construction / Nouvelle Construction

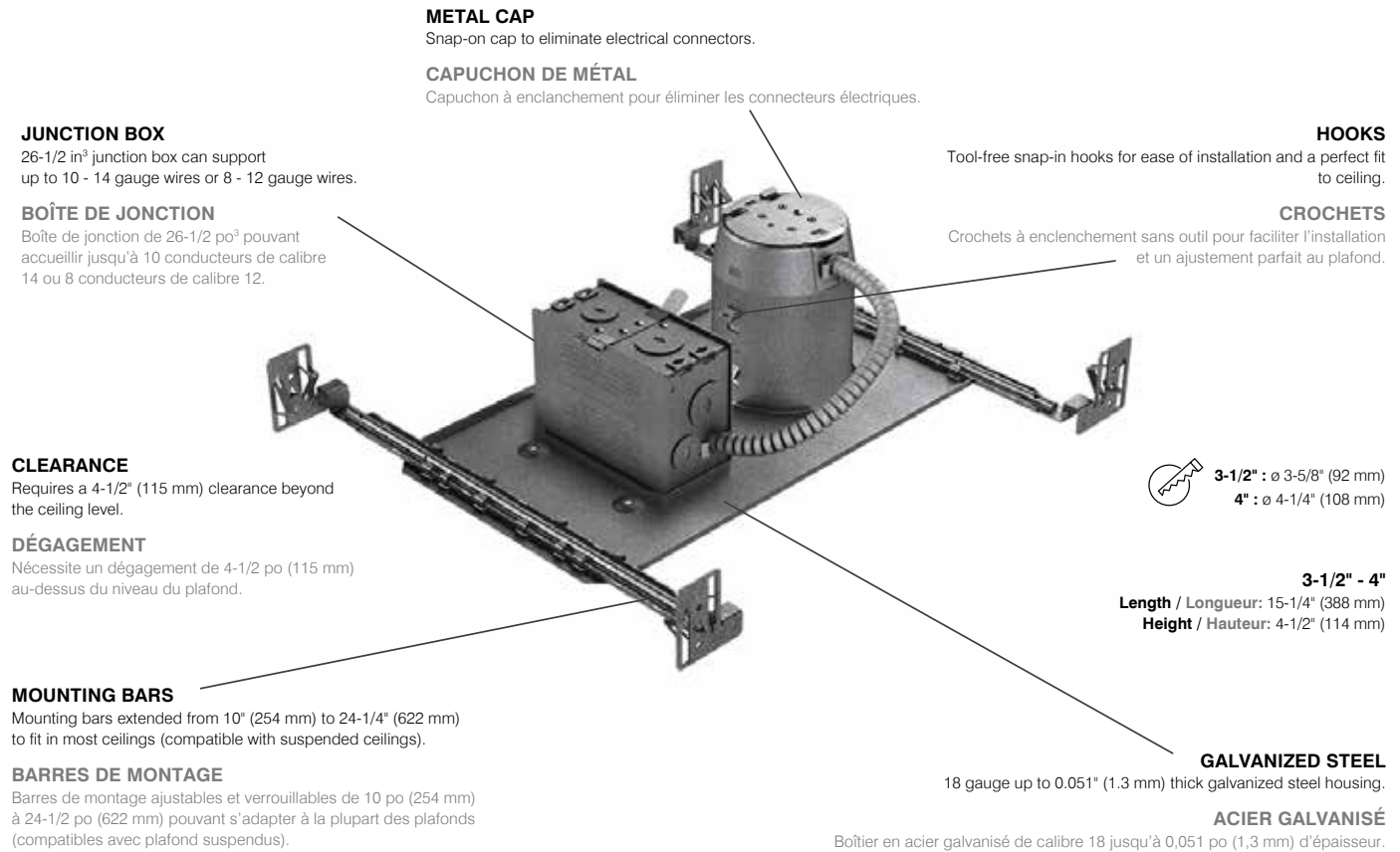

FEATURES / CARACTÉRISTIQUES

- Approved for installation in an insulated ceiling in direct contact with insulated material (except polyurethane) (10W housing)
 - 26-1/2 in³ junction box can support up to 10 - 14 gauge wires or 8 - 12 gauge wires
 - 18-gauge up to 0.051" (1.3 mm) thick galvanized steel housing
 - Can fit ceilings up to 2" (51 mm) thick
 - Tool-free snap-in hooks for ease of installation
 - Mounting bars extended from 10" (254 mm) to 24-1/2" (622 mm) to fit in most ceilings (compatibles with suspended ceilings)
 - Perfect fit to ceiling, ensuring no light leakage
 - cULus listed for damp locations (all trims) and for wet locations (shower trims)
 - Certified Air Tight ASTM E283 (10W MAX)
 - 3-year limited warranty on electronic transformers and 1-year on components
-
- Approuvé pour l'installation dans un plafond isolé en contact direct avec un matériau isolant (sauf polyuréthane) (boîtier 10W)
 - Boîte de jonction de 26-1/2 po³ pouvant accueillir jusqu'à 10 conducteurs de calibre 14 ou 8 conducteurs de calibre 12
 - Boîtier en acier galvanisé de calibre 18 jusqu'à 0,051 po (1,3 mm) d'épaisseur
 - S'adapte aux plafonds jusqu'à 2 po (51 mm) d'épaisseur
 - Crochets à enclenchement sans outil pour faciliter l'installation
 - Barres de montage ajustables et verrouillables de 10 po (254 mm) à 24-1/2 po (622 mm) pouvant s'adapter à la plupart des plafonds (compatibles avec les plafonds suspendus)
 - Ajustement parfait au plafond, sans fuite de lumière
 - Homologation cULus pour endroits humides (toutes les garnitures) et pour endroits mouillés (garnitures de douches)
 - Homologation étanche à l'air ASTM E283 (10W MAX)
 - Garantie limitée de 3 ans sur les transformateurs électroniques et 1 an sur les composants

3 1/2"

NW35GU10-10W



ORDERING CODES / CODES DE COMMANDE

MODEL / MODÈLE	SERIES / SÉRIES	SOURCE	WATTAGE
NW	35	GU10	-10W
NW New Construction Housing Boîtier nouvelle construction	35 3-1/2" Series / Série 3-1/2 po	GU10 GU10 (LED / DEL)	-10W 10W

NW35MR16



ORDERING CODES / CODES DE COMMANDE

MODEL / MODÈLE	SERIES / SÉRIES	SOURCE	VOLTAGE / TENSION	WATTAGE
NW	35	MR16		
NW New Construction Housing Boîtier nouvelle construction	35 3-1/2" Series Série 3-1/2 po	MR16 MR16 GU5.3 (LED / DEL) MR16 GU5.3	-120 120 Volts (ELV) -277 277 Volts (ELV)	-10W 10W (LED / DEL) -50W 50W (Halogen / Halogène)*
			-120D 120 Volts (0-10V) -277D 277 Volts (0-10V)	-50W 50W (Halogen / Halogène)*

*Not for isolated and Air Tight ceiling
Pour plafond non-isolé et non étanche à l'air

4"

NW40GU10-10W



ORDERING CODES / CODES DE COMMANDE

MODEL / MODÈLE	SERIES / SÉRIES	SOURCE	WATTAGE
NW	40	GU10	-10W
NW New Construction Housing Boîtier nouvelle construction	40 4" Series / Série 4 po	GU10 GU10 (LED / DEL)	-10W 10W

NW40MR16



ORDERING CODES / CODES DE COMMANDE

MODEL / MODÈLE	SERIES / SÉRIES	SOURCE	VOLTAGE / TENSION	WATTAGE
NW	40	MR16		
NW New Construction Housing Boîtier nouvelle construction	40 4" Series Série 4 po	MR16 MR16 GU5.3 (LED / DEL) MR16 GU5.3	-120 120 Volts (ELV) -277 277 Volts (ELV)	-10W 10W (LED / DEL) -50W 50W (Halogen / Halogène)*
			-120D 120 Volts (0-10V) -277D 277 Volts (0-10V)	-50W 50W (Halogen / Halogène)*

*Not for isolated and Air Tight ceiling
Pour plafond non-isolé et non étanche à l'air

NW40PAR-10W



ORDERING CODES / CODES DE COMMANDE

MODEL / MODÈLE	SERIES / SÉRIES	SOURCE	WATTAGE
NW	40	PAR	-10W
NW New Construction Housing Boîtier nouvelle construction	40 4" Series / Série 4 po	PAR PAR20 (LED / DEL)	-10W 10W

HOUSINGS / BOÎTIERS

Classic New Construction (IC) / Nouvelle Construction isolé (IC) classique

JUNCTION BOX

33-1/2 in³ junction box can support up to 10 - 14 gauge wires or 8 - 12 gauge wires.

BOÎTE DE JONCTION

Boîte de jonction de 33-1/2 po³ pouvant accueillir jusqu'à 10 conducteurs de calibre 14 ou 8 conducteurs de calibre 12.

CLEARANCE

Requires a 6-1/16" (154 mm) clearance beyond the ceiling level.

DÉGAGEMENT

Nécessite un dégagement de 6-1/16 po (154 mm) au-dessus du niveau du plafond.

MOUNTING BARS

Mounting bars extended from 10" (254 mm) to 24-1/4" (622 mm) to fit in most ceilings (compatible with suspended ceilings).

BARRES DE MONTAGE

Barres de montage ajustables et verrouillables de 10 po (254 mm) à 24-1/2 po (622 mm) pouvant s'adapter à la plupart des plafonds (compatibles avec plafond suspendus).

GALVANIZED STEEL

18 gauge up to 0.051" (1.3 mm) thick galvanized steel housing.

ACIER GALVANISÉ

Boîtier en acier galvanisé de calibre 18 jusqu'à 0,051 po (1,3 mm) d'épaisseur.



3-1/2" : ø 3-5/8" (92 mm)

4" : ø 4-1/4" (108 mm)

3-1/2" - 4"

Length / Longueur: 15-5/16" (389 mm)

Height / Hauteur: 6-1/16" (154 mm)

HOOKS

Tool-free snap-in hooks for ease of installation and a perfect fit to ceiling.

CROCHETS

Crochets à enclenchement sans outil pour faciliter l'installation et un ajustement parfait au plafond.

FEATURES / CARACTÉRISTIQUES

- Different housings available for Air Tight LED lamps and halogen lamps.
 - 33-1/2 in³ junction box can support up to 10 - 14 gauge wires or 8 - 12 gauge wires
 - 18-gauge up to 0.051" (1.3 mm) thick galvanized steel housing
 - Can fit ceilings up to 2" (51 mm) thick
 - Tool-free snap-in hooks for ease of installation
 - Mounting bars extended from 10" (254 mm) to 24-1/2" (622 mm) to fit in most ceilings (compatibles with suspended ceilings).
 - Perfect fit to ceiling, ensuring no light leakage
 - cULus listed for damp locations (all trims) and for wet locations (shower trims)
 - Certified Air Tight ASTM E283 (10W MAX)
 - 3-year limited warranty on electronic transformers and 1-year on components
-
- Différents boîtiers disponibles pour lampes à DEL étanche à l'air et lampes halogènes.
 - Boîte de jonction de 33-1/2 po³ pouvant accueillir jusqu'à 10 conducteurs de calibre 14 ou 8 conducteurs de calibre 12
 - Boîtier en acier galvanisé de calibre 18 jusqu'à 0,051 po (1,3 mm) d'épaisseur
 - S'adapte aux plafonds jusqu'à 2 po (51 mm) d'épaisseur
 - Crochets à enclenchement sans outil pour faciliter l'installation
 - Barres de montage ajustables et verrouillables de 10 po (254 mm) à 24-1/2 po (622 mm) pouvant s'adapter à la plupart des plafonds (compatibles avec les plafonds suspendus)
 - Ajustement parfait au plafond, sans fuite de lumière
 - Homologation cULus pour endroits humides (toutes les garnitures) et pour endroits mouillés (garnitures de douches)
 - Homologation étanche à l'air ASTM E283 (10W MAX)
 - Garantie limitée de 3 ans sur les transformateurs électroniques et 1 an sur les composants

3 1/2"

IC35GU10-10W



ORDERING CODES / CODES DE COMMANDE

MODEL / MODÈLE	SERIES / SÉRIES	SOURCE	WATTAGE
IC	35	GU10	-10W
IC Classic New Construction (IC) Housing Boîtier nouvelle construction isolé (IC) classique	35 3-1/2" Series / Série 3-1/2 po	GU10 GU10 (LED / DEL)	-10W 10W

IC35MR16



ORDERING CODES / CODES DE COMMANDE

MODEL / MODÈLE	SERIES / SÉRIES	SOURCE	VOLTAGE / TENSION	WATTAGE
IC	35	MR16		
IC Classic New Construction (IC) Housing Boîtier nouvelle construction isolé (IC) classique	35 3-1/2" Series Série 3-1/2 po	MR16 MR16 GU5.3 (LED / DEL) MR16 GU5.3	-120 120 Volts (ELV)	-10W 10W (LED / DEL)
			-277 277 Volts (ELV)	-37W 37W (Halogen / Halogène)*
			-120D 120 Volts (0-10V) -277D 277 Volts (0-10V)	-37W 37W (Halogen / Halogène)*

*Not for Air Tight ceiling
Pour plafond non étanche à l'air

4"

IC40GU10-10W

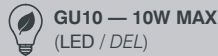

ORDERING CODES / CODES DE COMMANDE

MODEL / MODÈLE	SERIES / SÉRIES	SOURCE	WATTAGE
IC	40	GU10	-10W
IC Classic New Construction (IC) Housing Boîtier nouvelle construction isolé (IC) classique	40 4" Series / Série 4 po	GU10 GU10 (LED / DEL)	-10W 10W

IC40MR16



ORDERING CODES / CODES DE COMMANDE

MODEL / MODÈLE	SERIES / SÉRIES	SOURCE	VOLTAGE / TENSION	WATTAGE
IC	40	MR16		
IC Classic New Construction (IC) Housing Boîtier nouvelle construction isolé (IC) classique	40 4" Series Série 4 po	MR16 MR16 GU5.3 (LED / DEL) MR16 GU5.3	-120 120 Volts (ELV)	-10W 10W (LED / DEL)
			-277 277 Volts (ELV)	-37W 37W (Halogen / Halogène)*
			-120D 120 Volts (0-10V) -277D 277 Volts (0-10V)	-37W 37W (Halogen / Halogène)*

*Not for Air Tight ceiling
Pour plafond non étanche à l'air

IC40PAR-10W



ORDERING CODES / CODES DE COMMANDE

MODEL / MODÈLE	SERIES / SÉRIES	SOURCE	WATTAGE
IC	40	PAR	-10W
IC Classic New Construction (IC) Housing Boîtier nouvelle construction isolé (IC) classique	40 4" Series / Série 4 po	PAR PAR20 (LED / DEL)	-10W 10W

HOUSINGS / BOÎTIERS

Remodel / Rénovateur

FLEXIBLE CHANNEL

Flexible channel wire bracket made of 20 gauge steel, bending up to 45° vertically for ease of installation in confined spaces.

CANALISATION FLEXIBLE

Canalisation flexible pour le passage des fils en acier de calibre 20, permettant un pliage jusqu'à 45° vertical facilitant l'installation dans les endroits restreints.

CLEARANCE

Requires a 4-3/4" (121 mm) clearance beyond the ceiling level.

DÉGAGEMENT

Nécessite un dégagement de 4-3/4 po (121 mm) au-dessus du niveau du plafond.

HOOKS

Tool-free snap-in hooks for ease of installation.

CROCHETS

Crochets à enclenchement sans outil pour faciliter l'installation.

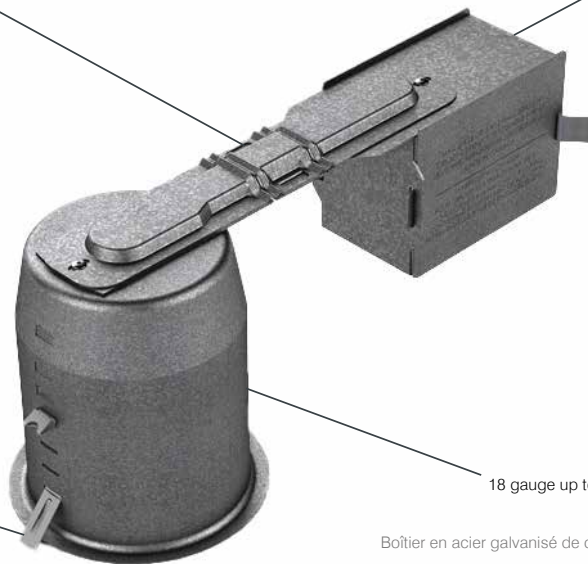

JUNCTION BOX

19-1/2 in³ junction box can support up to 10 - 14 gauge wires or 8 - 12 gauge wires.

BOÎTE DE JONCTION

Boîte de jonction de 19-1/2 po³ pouvant accueillir jusqu'à 10 conducteurs de calibre 14 ou 8 conducteurs de calibre 12.



3-1/2" : ø 3-5/8" (92 mm)
4" : ø 4-1/4" (108 mm)

3-1/2"

Length / Longueur: 10-3/4" (273 mm)
Height / Hauteur: 4-3/4" (121 mm)

4"

Length / Longueur: 11" (280 mm)
Height / Hauteur: 4-3/4" (121 mm)

GALVANIZED STEEL

18 gauge up to 0.051" (1.3 mm) thick galvanized steel housing.

ACIER GALVANISÉ

Boîtier en acier galvanisé de calibre 18 jusqu'à 0,051 po (1,3 mm) d'épaisseur.

FEATURES / CARACTÉRISTIQUES

- Approved for installation in an insulated ceiling in direct contact with insulated material (except polyurethane) (10W housing)
 - 19-1/2 in³ junction box can support up to 10 - 14 gauge wires or 8 - 12 gauge wires
 - 18-gauge up to 0.051" (1.3 mm) thick galvanized steel housing
 - Can fit ceilings up to 2" (51 mm) thick
 - Flexible channel wire bracket made of 20 gauge steel, bending up to 45° vertically for ease of installation in confined spaces
 - Tool-free snap-in hooks for ease of installation
 - Perfect fit to ceiling, ensuring no light leakage
 - cULus listed for damp locations (all trims) and for wet locations (shower trims)
 - Certified Air Tight ASTM E283 (10W MAX)
 - 3-year limited warranty on electronic transformers and 1-year on components
-
- Approuvé pour l'installation dans un plafond isolé en contact direct avec un matériau isolant (sauf polyuréthane) (boîtier 10W)
 - Boîte de jonction de 19-1/2 po³ pouvant accueillir jusqu'à 10 conducteurs de calibre 14 ou 8 conducteurs de calibre 12
 - Boîtier en acier galvanisé de calibre 18 jusqu'à 0,051 po (1,3 mm) d'épaisseur
 - S'adapte aux plafonds jusqu'à 2 po (51 mm) d'épaisseur
 - Canalisation flexible pour les passage des fils en acier de calibre 20, permettant un pliage jusqu'à 45° vertical facilitant l'installation dans les endroits restreints
 - Crochets à enclenchement sans outil pour faciliter l'installation
 - Ajustement parfait au plafond, sans fuite de lumière
 - Homologation cULus pour endroits humides (toutes les garnitures) et pour endroits mouillés (garnitures de douches)
 - Homologation étanche à l'air ASTM E283 (10W MAX)
 - Garantie limitée de 3 ans sur les transformateurs électroniques et 1 an sur les composants

3 1/2"

RE35GU10-10W

 **GU10 — 10W MAX**
(LED / DEL)



ORDERING CODES / CODES DE COMMANDE

MODEL / MODÈLE	SERIES / SÉRIES	SOURCE	WATTAGE
RE	35	GU10	-10W
RE Remodel Housing Boîtier rénovateur	35 3-1/2" Series / Série 3-1/2 po	GU10 GU10 (LED / DEL)	-10W 10W

RE35MR16

 **MR16 GU5.3 — 10W MAX**
(LED / DEL)



 **MR16 GU5.3 — 37W MAX**
(Halogen / Halogène)



ORDERING CODES / CODES DE COMMANDE

MODEL / MODÈLE	SERIES / SÉRIES	SOURCE	VOLTAGE TENSION	WATTAGE
RE	35	MR16		
RE Remodel Housing Boîtier rénovateur	35 3-1/2" Series Série 3-1/2 po	MR16 MR16 GU5.3 (LED / DEL) MR16 GU5.3	-120 120 Volts (ELV) -277 277 Volts (ELV)	-10W 10W (LED / DEL) -37W 37W (Halogen / Halogène)*

*Not for isolated and Air Tight ceiling
Pour plafond non-isolé et non étanche à l'air

4"

RE40GU10-10W

 **GU10 — 10W MAX**
(LED / DEL)



ORDERING CODES / CODES DE COMMANDE

MODEL / MODÈLE	SERIES / SÉRIES	SOURCE	WATTAGE
RE	40	GU10	-10W
RE Remodel Housing Boîtier rénovateur	40 4" Series / Série 4 po	GU10 GU10 (LED / DEL)	-10W 10W

RE40MR16

 **MR16 GU5.3 — 10W MAX**
(LED / DEL)



 **MR16 GU5.3 — 37W MAX**
(Halogen / Halogène)



ORDERING CODES / CODES DE COMMANDE

MODEL / MODÈLE	SERIES / SÉRIES	SOURCE	VOLTAGE TENSION	WATTAGE
RE	40	MR16		
RE Remodel Housing Boîtier rénovateur	40 4" Series Série 4 po	MR16 MR16 GU5.3 (LED / DEL) MR16 GU5.3	-120 120 Volts (ELV) -277 277 Volts (ELV)	-10W 10W (LED / DEL) -37W 37W (Halogen / Halogène)*

*Not for isolated and Air Tight ceiling
Pour plafond non-isolé et non étanche à l'air

RE40PAR-10W

 **PAR20 — 10W MAX**
(LED / DEL)



ORDERING CODES / CODES DE COMMANDE

MODEL / MODÈLE	SERIES / SÉRIES	SOURCE	WATTAGE
RE	40	PAR	-10W
RE Remodel Housing Boîtier rénovateur	40 4" Series / Série 4 po	PAR PAR20 (LED / DEL)	-10W 10W

HOUSINGS / BOÎTIERS

CA2550U

White Painted Remodel / Rénovateur peint blanc

(No trim required / Aucune garniture requise)



PAR20 — 50W MAX
(Halogen / Halogène)

Ø 3-5/8" (92 mm)

Length / Longueur: 11-9/16" (294 mm)
Height / Hauteur: 6" (152 mm)



CLEARANCE
Requires a 6" (152 mm) clearance beyond the ceiling level.

DÉGAGEMENT
Nécessite un dégagement de 6 po (152 mm) au-dessus du niveau du plafond.

JUNCTION BOX
19-1/2 in³ junction box can support up to 10 - 14 gauge wires or 8 - 12 gauge wires.

BOÎTE DE JONCTION
Boîte de jonction de 19-1/2 po³ pouvant accueillir jusqu'à 10 conducteurs de calibre 14 ou 8 conducteurs de calibre 12.

COMPATIBLE COLLARS

C2550 Collar (all finishes are available).
A baffle (BAFRE2550) or a reflector (REFRE2550) is required to secure the C2550 collar.
(Ordering codes available in the accessories section)

COLERETTES COMPATIBLES

Colerette C2550 (tous les finis sont disponibles).
La colerette C2550 requiert un déflecteur (BAFRE2550) ou un réflecteur (REFRE2550) pour être fixée.
(Codes de commande disponibles dans la section des accessoires)

FEATURES / CARACTÉRISTIQUES

- 18-gauge up to 0.051" (1.3 mm) thick galvanized steel housing
 - Porcelain; medium base socket (E26), Pre-wired with 18 gauge wire SEW 200°C connected to the junction box
 - Can fit ceilings up to 7/8" (22 mm) thick
 - Flexible channel wire bracket made of 20 gauge steel, bending up to 45° vertically for ease of installation in confined spaces
 - Hook for ease of installation and perfect fit to ceiling.
 - Perfect fit to ceiling, ensuring no light leakage
 - cULus listed for damp locations
 - 1-year limited warranty on components
- Boîtier en acier galvanisé de calibre 18 jusqu'à 0,051 po (1,3 mm) d'épaisseur
 - Porcelaine; douille à culot moyen (E26), Pré-filé avec fil de calibre 18 en SEW 200°C branché à la boîte de raccordement
 - S'adapte aux plafonds jusqu'à 7/8 po (22 mm) d'épaisseur
 - Canalisation flexible pour les passage des fils en acier de calibre 20, permettant un pliage jusqu'à 45° vertical facilitant l'installation dans les endroits restreints
 - Crochets pour faciliter l'installation et un ajustement parfait au plafond.
 - Ajustement parfait au plafond, sans fuite de lumière
 - Homologation cULus pour endroits humides
 - Garantie limitée de 1 an sur les composants

ORDERING CODES / CODES DE COMMANDE

MODEL MODÈLE	SERIES SÉRIES	BAFFLE (BAFRE2550) / REFLECTOR (REFRE2550) DÉFLECTEUR (BAFRE2550) / RÉFLECTEUR (REFRE2550) OPTIONAL / OPTIONNEL	
CA	2550U	PHENOLIC BAFFLE DÉFLECTEUR PHÉNOLIQUE	SPECULAR REFLECTOR RÉFLECTEUR SPÉCULAIRE
CA Remodel Housing Boîtier rénovation	2550U Universal 3-1/2" Series Série 3-1/2 po universel	-01 White / Blanc -02 Black / Noir	-BK Black / Noir -CL Clear / Clair

Required if you want to use a collar
Requis si vous souhaitez utiliser une colerette

CA2575

White Painted Remodel / Rénovateur peint blanc

(No trim required / Aucune garniture requise)



PAR30 — 75W MAX
(Halogen / Halogène)

ø 4-5/8" (117 mm)

Length / Longueur: 13-1/8" (333 mm)
Height / Hauteur: 6-1/8" (156 mm)



CLEARANCE
Requires a 6-1/8" (156 mm) clearance beyond the ceiling level.

DÉGAGEMENT
Nécessite un dégagement de 6-1/8 po (156 mm) au-dessus du niveau du plafond.

JUNCTION BOX
19-1/2 in³ junction box can support up to 10 - 14 gauge wires or 8 - 12 gauge wires.

BOÎTE DE JONCTION
Boîte de jonction de 19-1/2 po³ pouvant accueillir jusqu'à 10 conducteurs de calibre 14 ou 8 conducteurs de calibre 12.

COMPATIBLE COLLARS

C2575 Collar (all finishes are available).
A baffle (BAFRE2575) or a reflector (REFRE2575) is required to secure the C2575 collar.
(Ordering codes available in the accessories section)

COLERETTES COMPATIBLES

Colerette C2575 (tous les finis sont disponibles).
La colerette C2575 requiert un déflecteur (BAFRE2575) ou un réflecteur (REFRE2575) pour être fixée.
(Codes de commande disponibles dans la section des accessoires)

FEATURES / CARACTÉRISTIQUES

- 18-gauge up to 0.051" (1.3 mm) thick galvanized steel housing
 - Porcelain; medium base socket (E26), Pre-wired with 18 gauge wire SEW 200°C connected to the junction box
 - Can fit ceilings up to 7/8" (22 mm) thick
 - Flexible channel wire bracket made of 20 gauge steel, bending up to 45° vertically for ease of installation in confined spaces
 - Hook for ease of installation and perfect fit to ceiling.
 - Perfect fit to ceiling, ensuring no light leakage
 - cULus listed for damp locations
 - 1-year limited warranty on components
- Boîtier en acier galvanisé de calibre 18 jusqu'à 0,051 po (1,3 mm) d'épaisseur
 - Porcelaine; douille à culot moyen (E26), Pré-filé avec fil de calibre 18 en SEW 200°C branché à la boîte de raccordement
 - S'adapte aux plafonds jusqu'à 7/8 po (22 mm) d'épaisseur
 - Canalisation flexible pour les passage des fils en acier de calibre 20, permettant un pliage jusqu'à 45° vertical facilitant l'installation dans les endroits restreints
 - Crochets pour faciliter l'installation et un ajustement parfait au plafond.
 - Ajustement parfait au plafond, sans fuite de lumière
 - Homologation cULus pour endroits humides
 - Garantie limitée de 1 an sur les composants

ORDERING CODES / CODES DE COMMANDE

MODEL MODÈLE	SERIES SÉRIES	BAFFLE (BAFRE2575) / REFLECTOR (REFRE2575) DÉFLECTEUR (BAFRE2575) / RÉFLECTEUR (REFRE2575) <i>OPTIONAL / OPTIONNEL</i>	
CA	2575	PHENOLIC BAFFLE DÉFLECTEUR PHÉNOLIQUE	SPECULAR REFLECTOR RÉFLECTEUR SPÉCULAIRE
CA Remodel Housing Boîtier rénovation	2575 4-3/8" Series Série 4-3/8 po	-01 White / Blanc -02 Black / Noir	-BK Black / Noir -CL Clear / Clair

Required if you want to use a collar
Requis si vous souhaitez utiliser une colerette

Housings/Trims Compatibility

Compatibilité boîtiers/garnitures

TRIMS GARNITURES 3-1/2"	REMODEL RÉNOVATEUR					NEW CONSTRUCTION NOUVELLE CONSTRUCTION							CLASSIC NEW CONSTRUCTION (IC) NOUVELLE CONSTRUCTION ISOLÉ (IC) CLASSIQUE						
	RE35GU10-10W	RE35MR16-120-10W	RE35MR16-120-37W	RE35MR16-277-10W	RE35MR16-277-37W	NW35GU10-10W	NW35MR16-120-10W	NW35MR16-120-50W	NW35MR16-120D-50W	NW35MR16-277-10W	NW35MR16-277-50W	NW35MR16-277D-50W	IC35GU10-10W	IC35MR16-120-10W	IC35MR16-120-50W	IC35MR16-120D-50W	IC35MR16-277-10W	IC35MR16-277-50W	IC35MR16-277D-50W
R3151	•	•	•	•	•	•	•	•	•	•	•	•	•	•	•	•	•	•	•
R3151W	•	•	•	•	•	•	•	•	•	•	•	•	•	•	•	•	•	•	•
R3450D	•	•	•	•	•	•	•	•	•	•	•	•	•	•	•	•	•	•	•
R3470	•	•	•	•	•	•	•	•	•	•	•	•	•	•	•	•	•	•	•
R3652	•	•	•	•	•	•	•	•	•	•	•	•	•	•	•	•	•	•	•
S3145	•	•	•	•	•	•	•	•	•	•	•	•	•	•	•	•	•	•	•
S3151	•	•	•	•	•	•	•	•	•	•	•	•	•	•	•	•	•	•	•
S3450	•	•	•	•	•	•	•	•	•	•	•	•	•	•	•	•	•	•	•
S3450D	•	•	•	•	•	•	•	•	•	•	•	•	•	•	•	•	•	•	•
T3000	•	•	•	•	•	•	•	•	•	•	•	•	•	•	•	•	•	•	•
T3100	•	•	•	•	•	•	•	•	•	•	•	•	•	•	•	•	•	•	•
T3125	•	•	•	•	•	•	•	•	•	•	•	•	•	•	•	•	•	•	•
T3145	•	•	•	•	•	•	•	•	•	•	•	•	•	•	•	•	•	•	•
T3145D	•	•	•	•	•	•	•	•	•	•	•	•	•	•	•	•	•	•	•
T3145DG	•	•	•	•	•	•	•	•	•	•	•	•	•	•	•	•	•	•	•
T3145W	•	•	•	•	•	•	•	•	•	•	•	•	•	•	•	•	•	•	•
T3200	•	•	•	•	•	•	•	•	•	•	•	•	•	•	•	•	•	•	•
T3250	•	•	•	•	•	•	•	•	•	•	•	•	•	•	•	•	•	•	•
T3450	•	•	•	•	•	•	•	•	•	•	•	•	•	•	•	•	•	•	•
T3450D	•	•	•	•	•	•	•	•	•	•	•	•	•	•	•	•	•	•	•
T3450W	•	•	•	•	•	•	•	•	•	•	•	•	•	•	•	•	•	•	•
T3850	•	•	•	•	•	•	•	•	•	•	•	•	•	•	•	•	•	•	•

TRIMS GARNITURES 4"	REMODEL RÉNOVATEUR						NEW CONSTRUCTION NOUVELLE CONSTRUCTION							CLASSIC NEW CONSTRUCTION (IC) NOUVELLE CONSTRUCTION ISOLÉ (IC) CLASSIQUE									
	RE40GU10-10W	RE40MR16-120-10W	RE40MR16-120-37W	RE40MR16-277-10W	RE40MR16-277-37W	RE40PAR-10W	NW40GU10-10W	NW40MR16-120-10W	NW40MR16-120-50W	NW40MR16-120D-50W	NW40MR16-277-10W	NW40MR16-277-50W	NW40MR16-277D-50W	NW40PAR-10W	IC40GU10-10W	IC40MR16-120-10W	IC40MR16-120-50W	IC40MR16-120D-50W	IC40MR16-277-10W	IC40MR16-277-50W	IC40MR16-277D-50W	IC40PAR-10W	
A2000						•								•								•	
A2100						•								•								•	
A2450S						•								•								•	
D2000						•								•								•	
D2100						•								•								•	
R2000	•	•	•	•	•		•	•	•	•	•	•	•		•	•	•	•	•	•	•	•	
R2100	•	•	•	•	•		•	•	•	•	•	•	•		•	•	•	•	•	•	•	•	
S2000	•	•	•	•	•		•	•	•	•	•	•	•		•	•	•	•	•	•	•	•	
S2100	•	•	•	•	•		•	•	•	•	•	•	•		•	•	•	•	•	•	•	•	
T2000	•	•	•	•	•		•	•	•	•	•	•	•		•	•	•	•	•	•	•	•	

3 1/2"

R3151



18

R3151W



19

R3450D



20

R3470



21

R3652



22

S3145



23

S3151



24

S3450



25

S3450D



26

T3000



28

T3100



29

T3125



30

T3145



31

T3145D



32

T3145DG



33

T3145W



34

T3200



35

T3250



36

T3450



37

T3450D



39

T3450W



40

T3850



41

A2000



44

A2100



45

A2450S



46

D2000



47

D2100



48

R2000



49

R2100



50

S2000



51

S2100



52

T2000



53





3 1/2"

3 1/2"

R3151

Low Profile Regressed Square Trim with Square Pinhole Opening

Garniture carrée en retrait mince avec ouverture réduite carrée



Damp locations
Endroits humides



Ø 3-5/8" (92 mm)



GU10 (LED/DEL)
MR16 (LED/DEL)



MR16 (Halogen/Halogène)



R3151-12BR
(illustrated / illustrée)
(Lamp not included / Lampe non incluse)

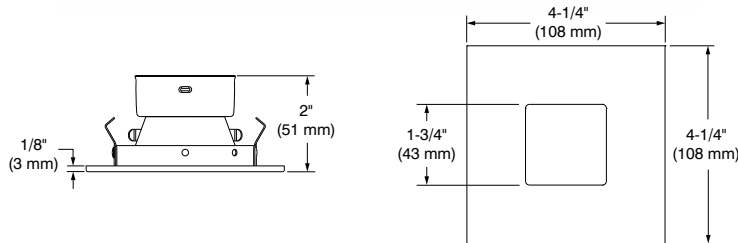

ORDERING CODES / CODES DE COMMANDE

Options in red may result in a longer lead time.
Les options en rouge peuvent générer un délai de production plus long.

MODEL / MODÈLE	TRIM FINISHES / FINIS DE GARNITURE	REFLECTORS / RÉFLECTEURS
R3151	POWDER COAT PAINTED / RECOUVREMENT EN POUDRE (Standard)	ANODIZED / ANODISÉ
R3151	<ul style="list-style-type: none"> -01 White / Blanc -02 Black / Noir -11 Matte White / Blanc mat -22 Matte Black / Noir mat -25 Polar Grey / Gris polaire -05 <i>Architectural Bronze / Bronze architectural</i> -06 <i>Antique Copper / Cuivre antique</i> 	<p>Standard : Anodized Aluminum / Aluminium anodisé</p> <p>PAINT / PEINT</p> <ul style="list-style-type: none"> -01 White / Blanc -02 Black / Noir -11 Matte White / Blanc mat <p>SPECULAR / SPÉCULAIRE</p> <ul style="list-style-type: none"> CL Clear / Clair BK Black / Noir
	<p>PLATED / PLAQUÉ (Premium)</p> <ul style="list-style-type: none"> -04BR Brushed Chrome / Chrome brossé -12BR Brushed Nickel / Nickel brossé -03 <i>24K Gold Plated / Plaqué or 24K</i> -04 <i>Chrome / Chrome</i> -13 <i>Satin Nickel / Nickel satiné</i> 	

AVAILABLE HOUSINGS / BOÎTIERS DISPONIBLES

SOURCE	REMODEL RÉNOVATEUR	NEW CONSTRUCTION NOUVELLE CONSTRUCTION	CLASSIC NEW CONSTRUCTION (IC) NOUVELLE CONSTRUCTION ISOLÉ (IC) CLASSIQUE
GU10 (LED / DEL)	RE35GU10-10W	NW35GU10-10W	IC35GU10-10W
MR16 (LED / DEL)	RE35MR16-120-10W RE35MR16-277-10W	NW35MR16-120-10W NW35MR16-277-10W	IC35MR16-120-10W IC35MR16-277-10W
MR16 (Halogen / Halogène)	RE35MR16-120-37W RE35MR16-277-37W	NW35MR16-120-50W NW35MR16-277-50W NW35MR16-120D-50W NW35MR16-277D-50W	IC35MR16-120-37W IC35MR16-277-37W IC35MR16-120D-37W IC35MR16-277D-37W

R3151W

Low Profile Regressed Adjustable Square Wall Wash Trim with Square Pinhole Opening

Garniture carrée orientable en retrait mince pour éclairage mural avec ouverture réduite carrée



Damp locations
Endroits humides



ø 3-5/8" (92 mm)



GU10 (LED/DEL)
MR16 (LED/DEL)



MR16 (Halogen/Halogène)



R3151W-22
(illustrated / illustrée)
(Lamp not included / Lampe non incluse)

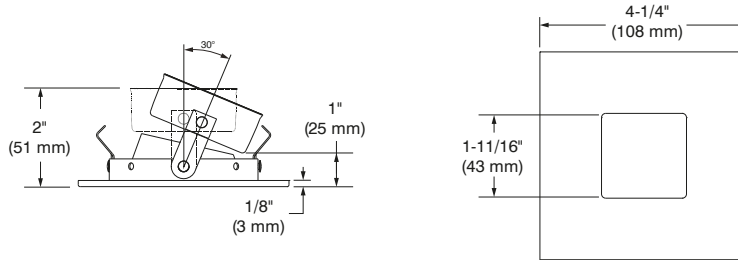

ORDERING CODES / CODES DE COMMANDE

Options in red may result in a longer lead time.
Les options en rouge peuvent générer un délai de production plus long.

MODEL / MODÈLE	TRIM FINISHES / FINIS DE GARNITURE	REFLECTORS / RÉFLECTEURS
R3151W	POWDER COAT PAINTED / RECOUVREMENT EN POUDRE (Standard)	ANODIZED / ANODISÉ
R3151W	<ul style="list-style-type: none"> -01 White / Blanc -02 Black / Noir -11 Matte White / Blanc mat -22 Matte Black / Noir mat -25 Polar Grey / Gris polaire -05 <i>Architectural Bronze / Bronze architectural</i> -06 <i>Antique Copper / Cuivre antique</i> 	<ul style="list-style-type: none"> Standard : Anodized Aluminum / Aluminium anodisé
	PLATED / PLAQUÉ (Premium)	PAINTE / PEINT
	<ul style="list-style-type: none"> -04BR Brushed Chrome / Chrome brossé -12BR Brushed Nickel / Nickel brossé -03 <i>24K Gold Plated / Plaqué or 24K</i> -04 <i>Chrome / Chrome</i> -13 <i>Satin Nickel / Nickel satiné</i> 	<ul style="list-style-type: none"> -01 White / Blanc -02 Black / Noir -11 Matte White / Blanc mat
		SPECULAR / SPÉCULAIRE
		<ul style="list-style-type: none"> CL Clear / Clair BK Black / Noir

AVAILABLE HOUSINGS / BOÎTIERS DISPONIBLES

SOURCE	REMODEL RÉNOVATEUR	NEW CONSTRUCTION NOUVELLE CONSTRUCTION	CLASSIC NEW CONSTRUCTION (IC) NOUVELLE CONSTRUCTION ISOLÉ (IC) CLASSIQUE
GU10 (LED / DEL)	RE35GU10-10W	NW35GU10-10W	IC35GU10-10W
MR16 (LED / DEL)	RE35MR16-120-10W RE35MR16-277-10W	NW35MR16-120-10W NW35MR16-277-10W	IC35MR16-120-10W IC35MR16-277-10W
MR16 (Halogen / Halogène)	RE35MR16-120-37W RE35MR16-277-37W	NW35MR16-120-50W NW35MR16-277-50W NW35MR16-120D-50W NW35MR16-277D-50W	IC35MR16-120-37W IC35MR16-277-37W IC35MR16-120D-37W IC35MR16-277D-37W

3 1/2"

R3450D

Low Profile Adjustable Regressed Trim

Garniture orientable en retrait mince



Damp locations
Endroits humides



ø 3-5/8" (92 mm)



GU10 (LED/DEL)
MR16 (LED/DEL)



MR16 (Halogen/Halogène)



R3450D-06
(illustrated / illustrée)
(Lamp not included / Lampe non incluse)

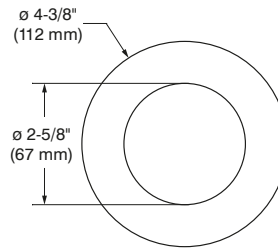
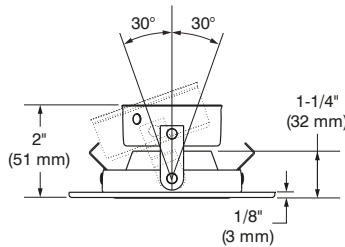

ORDERING CODES / CODES DE COMMANDE

Options in red may result in a longer lead time.
Les options en rouge peuvent générer un délai de production plus long.

MODEL / MODÈLE	TRIM FINISHES / FINIS DE GARNITURE	REFLECTORS / RÉFLECTEURS
R3450D	POWDER COAT PAINTED RECOUVREMENT EN POUDRE (Standard)	ANODIZED / ANODISÉ Standard : Anodized Aluminum Aluminium anodisé
R3450D	<p>-01 White / Blanc</p> <p>-02 Black / Noir</p> <p>-11 Matte White / Blanc mat</p> <p>-22 Matte Black / Noir mat</p> <p>-25 Polar Grey / Gris polaire</p> <p>-05 <i>Architectural Bronze / Bronze architecturale</i></p> <p>-06 <i>Antique Copper / Cuivre antique</i></p> <p>PLATED / PLAQUÉ (Premium)</p> <p>-04BR Brushed Chrome / Chrome brossé</p> <p>-12BR Brushed Nickel / Nickel brossé</p> <p>-03 <i>24K Gold Plated / Plaqué or 24K</i></p> <p>-04 <i>Chrome / Chrome</i></p> <p>-13 <i>Satin Nickel / Nickel satiné</i></p>	<p>PAINT / PEINT</p> <p>-01 White / Blanc</p> <p>-02 Black / Noir</p> <p>-11 Matte White / Blanc mat</p> <p>SPECULAR / SPÉCULAIRE</p> <p>CL Clear / Clair</p> <p>BK Black / Noir</p>

AVAILABLE HOUSINGS / BOÎTIERS DISPONIBLES

SOURCE	REMODEL RÉNOVATEUR	NEW CONSTRUCTION NOUVELLE CONSTRUCTION	CLASSIC NEW CONSTRUCTION (IC) NOUVELLE CONSTRUCTION ISOLÉ (IC) CLASSIQUE
GU10 (LED / DEL)	RE35GU10-10W	NW35GU10-10W	IC35GU10-10W
MR16 (LED / DEL)	RE35MR16-120-10W RE35MR16-277-10W	NW35MR16-120-10W NW35MR16-277-10W	IC35MR16-120-10W IC35MR16-277-10W
MR16 (Halogen / Halogène)	RE35MR16-120-37W RE35MR16-277-37W	NW35MR16-120-50W NW35MR16-277-50W NW35MR16-120D-50W NW35MR16-277D-50W	IC35MR16-120-37W IC35MR16-277-37W IC35MR16-120D-37W IC35MR16-277D-37W

R3470

Low Profile Regressed Trim Garniture en retrait mince



Damp locations
Endroits humides



Ø 3-5/8" (92 mm)



GU10 (LED/DEL)
MR16 (LED/DEL)



MR16 (Halogen/Halogène)



R3470-04
(illustrated / illustrée)
(Lamp not included / Lampe non incluse)

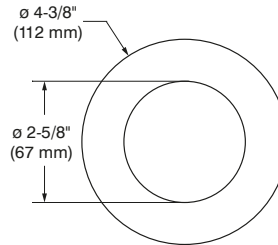
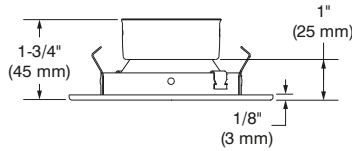

ORDERING CODES / CODES DE COMMANDE

Options in red may result in a longer lead time.
Les options en rouge peuvent générer un délai de production plus long.

MODEL / MODÈLE	TRIM FINISHES / FINIS DE GARNITURE	REFLECTORS / RÉFLECTEURS
R3470	POWDER COAT PAINTED / RECOUVREMENT EN POUDRE (Standard)	ANODIZED / ANODISÉ
R3470	<ul style="list-style-type: none"> -01 White / Blanc -02 Black / Noir -11 Matte White / Blanc mat -22 Matte Black / Noir mat -25 Polar Grey / Gris polaire -05 <i>Architectural Bronze / Bronze architectural</i> -06 <i>Antique Copper / Cuivre antique</i> 	<p>Anodized Aluminum / Aluminium anodisé</p> <p>PAINT / PEINT</p> <ul style="list-style-type: none"> -01 White / Blanc -02 Black / Noir -11 Matte White / Blanc mat
	PLATED / PLAQUÉ (Premium)	SPECULAR / SPÉCULAIRE
	<ul style="list-style-type: none"> -04BR Brushed Chrome / Chrome brossé -12BR Brushed Nickel / Nickel brossé -03 <i>24K Gold Plated / Plaqué or 24K</i> -04 <i>Chrome / Chrome</i> -13 <i>Satin Nickel / Nickel satiné</i> 	<ul style="list-style-type: none"> CL Clear / Clair BK Black / Noir

AVAILABLE HOUSINGS / BOÎTIERS DISPONIBLES

SOURCE	REMODEL RÉNOVATEUR	NEW CONSTRUCTION NOUVELLE CONSTRUCTION	CLASSIC NEW CONSTRUCTION (IC) NOUVELLE CONSTRUCTION ISOLÉ (IC) CLASSIQUE
GU10 (LED / DEL)	RE35GU10-10W	NW35GU10-10W	IC35GU10-10W
MR16 (LED / DEL)	RE35MR16-120-10W RE35MR16-277-10W	NW35MR16-120-10W NW35MR16-277-10W	IC35MR16-120-10W IC35MR16-277-10W
MR16 (Halogen / Halogène)	RE35MR16-120-37W RE35MR16-277-37W	NW35MR16-120-50W NW35MR16-277-50W NW35MR16-120D-50W NW35MR16-277D-50W	IC35MR16-120-37W IC35MR16-277-37W IC35MR16-120D-37W IC35MR16-277D-37W

3 1/2"

R3652

Low Profile Regressed Trim with Pinhole Opening

Garniture en retrait mince à ouverture réduite



Damp locations
Endroits humides



Ø 3-5/8" (92 mm)



GU10 (LED/DEL)
MR16 (LED/DEL)



MR16 (Halogen/Halogène)



R3652-25
(illustrated / illustrée)
(Lamp not included / Lampe non incluse)

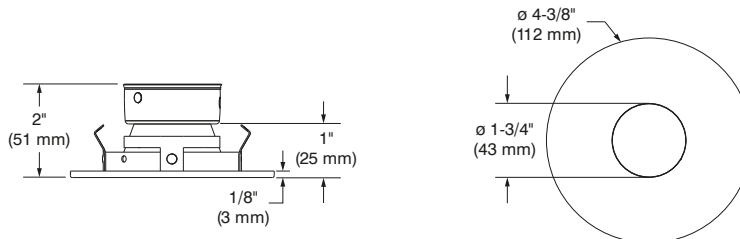

ORDERING CODES / CODES DE COMMANDE

Options in red may result in a longer lead time.
Les options en rouge peuvent générer un délai de production plus long.

MODEL / MODÈLE	TRIM FINISHES / FINIS DE GARNITURE	REFLECTORS / RÉFLECTEURS
R3652	POWDER COAT PAINTED / RECOUVREMENT EN POUDRE (Standard)	ANODIZED / ANODISÉ
R3652	<ul style="list-style-type: none"> -01 White / Blanc -02 Black / Noir -11 Matte White / Blanc mat -22 Matte Black / Noir mat -25 Polar Grey / Gris polaire -05 <i>Architectural Bronze / Bronze architecturale</i> -06 <i>Antique Copper / Cuivre antique</i> 	<p>Standard : Anodized Aluminum / Aluminium anodisé</p> <p>PAINT / PEINT</p> <ul style="list-style-type: none"> -01 White / Blanc -02 Black / Noir -11 Matte White / Blanc mat <p>SPECULAR / SPÉCULAIRE</p> <ul style="list-style-type: none"> CL Clear / Clair BK Black / Noir
	<p>PLATED / PLAQUÉ (Premium)</p> <ul style="list-style-type: none"> -04BR Brushed Chrome / Chrome brossé -12BR Brushed Nickel / Nickel brossé -03 <i>24K Gold Plated / Plaqué or 24K</i> -04 <i>Chrome / Chrome</i> -13 <i>Satin Nickel / Nickel satiné</i> 	

AVAILABLE HOUSINGS / BOÎTIERS DISPONIBLES

SOURCE	REMODEL RÉNOVATEUR	NEW CONSTRUCTION NOUVELLE CONSTRUCTION	CLASSIC NEW CONSTRUCTION (IC) NOUVELLE CONSTRUCTION ISOLÉ (IC) CLASSIQUE
GU10 (LED / DEL)	RE35GU10-10W	NW35GU10-10W	IC35GU10-10W
MR16 (LED / DEL)	RE35MR16-120-10W RE35MR16-277-10W	NW35MR16-120-10W NW35MR16-277-10W	IC35MR16-120-10W IC35MR16-277-10W
MR16 (Halogen / Halogène)	RE35MR16-120-37W RE35MR16-277-37W	NW35MR16-120-50W NW35MR16-277-50W NW35MR16-120D-50W NW35MR16-277D-50W	IC35MR16-120-37W IC35MR16-277-37W IC35MR16-120D-37W IC35MR16-277D-37W

S3145

Low Profile Square Shower Trim Garniture de douche carrée mince



Wet locations
Endroits mouillés



ø 3-5/8" (92 mm)



GU10 (LED/DEL)
MR16 (LED/DEL)



MR16 (Halogen/Halogène)



S3145-03
(illustrated / illustrée)
(Lamp not included / Lampe non incluse)

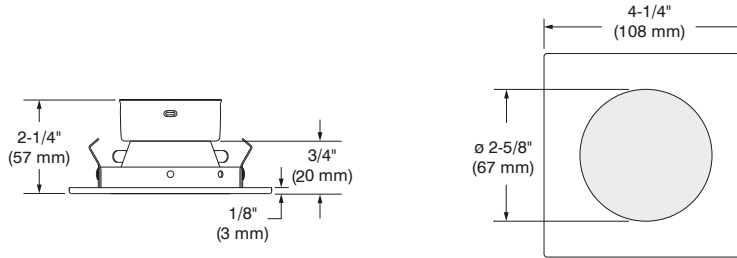

ORDERING CODES / CODES DE COMMANDE

Options in red may result in a longer lead time.
Les options en rouge peuvent générer un délai de production plus long.

MODEL / MODÈLE	LENSES / LENTILLES	TRIM FINISHES / FINIS DE GARNITURE	REFLECTORS / RÉFLECTEURS
S3145			
S3145	Standard : Frosted / Givrée C Clear / Claire FC Frosted with clear center Givrée avec centre clair	POWDER COAT PAINTED RECOUVREMENT EN POUDRE (Standard) White / Blanc -02 Black / Noir -11 Matte White / Blanc mat -22 Matte Black / Noir mat -25 Polar Grey / Gris polaire -05 <i>Architectural Bronze / Bronze architectural</i> -06 <i>Antique Copper / Cuivre antique</i> PLATED / PLAQUÉ (Standard) -04BR Brushed Chrome / Chrome brossé -12BR Brushed Nickel / Nickel brossé -03 <i>24K Gold Plated / Plaqué or 24K</i> -04 <i>Chrome / Chrome</i> -13 <i>Satin Nickel / Nickel satiné</i>	ANODIZED / ANODISÉ Standard : Anodized Aluminum / Aluminium anodisé PAINT / PEINT -01 White / Blanc -02 Black / Noir -11 Matte White / Blanc mat SPECULAR / SPÉCULAIRE CL Clear / Clair BK Black / Noir

Using LED lamps in shower trims and an Air Tight housing may result in its lifespan decrease. Contrast cannot be held responsible for LED lamps lifespan loss when used in totally enclosed spaces.

L'utilisation d'une lampe à DEL combinée à une garniture de douche et un boîtier étanche à l'air peut contribuer à diminuer la durée de vie de celle-ci. Contraste ne peut être tenue responsable de la diminution de la durée de vie d'une lampe à DEL utilisée en espace clos.

AVAILABLE HOUSINGS / BOÎTIERS DISPONIBLES

SOURCE	REMODEL RÉNOVATEUR	NEW CONSTRUCTION NOUVELLE CONSTRUCTION	CLASSIC NEW CONSTRUCTION (IC) NOUVELLE CONSTRUCTION ISOLÉ (IC) CLASSIQUE
GU10 (LED / DEL)	RE35GU10-10W	NW35GU10-10W	IC35GU10-10W
MR16 (LED / DEL)	RE35MR16-120-10W RE35MR16-277-10W	NW35MR16-120-10W NW35MR16-277-10W	IC35MR16-120-10W IC35MR16-277-10W
MR16 (Halogen / Halogène)	RE35MR16-120-37W RE35MR16-277-37W	NW35MR16-120-50W NW35MR16-277-50W NW35MR16-120D-50W NW35MR16-277D-50W	IC35MR16-120-37W IC35MR16-277-37W IC35MR16-120D-37W IC35MR16-277D-37W

3 1/2"

S3151

Low Profile Square Shower Trim with Square Pinhole Opening

Garniture de douche carrée mince à ouverture réduite carrée



Wet locations
Endroits mouillés



120V
277V



Ø 3-5/8" (92 mm)



GU10 (LED/DEL)
MR16 (LED/DEL)



MR16 (Halogen/Halogène)



S3151-05
(illustrated / illustrée)
(Lamp not included / Lampe non incluse)

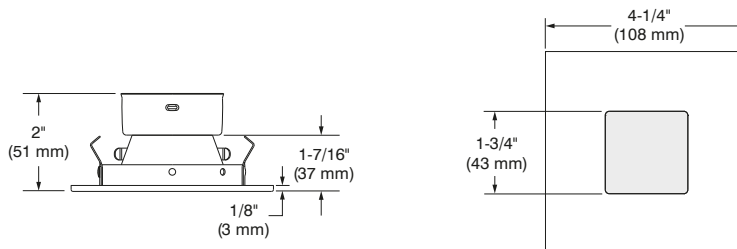

ORDERING CODES / CODES DE COMMANDE

Options in red may result in a longer lead time.
Les options en rouge peuvent générer un délai de production plus long.

MODEL / MODÈLE	LENSES / LENTILLES	TRIM FINISHES / FINIS DE GARNITURE	REFLECTORS / RÉFLECTEURS
S3151			
S3151	Standard : Frosted / Givrée	POWDER COAT PAINTED RECOUVREMENT EN POUDRE (Standard)	ANODIZED / ANODISÉ Standard : Anodized Aluminum / Aluminium anodisé
C	Clear / Claire	-01 White / Blanc -02 Black / Noir -11 Matte White / Blanc mat -22 Matte Black / Noir mat -25 Polar Grey / Gris polaire -05 Architectural Bronze / Bronze architectural -06 Antique Copper / Cuivre antique	PAINT / PEINT -01 White / Blanc -02 Black / Noir -11 Matte White / Blanc mat
		PLATED / PLAQUÉ (Standard) -04BR Brushed Chrome / Chrome brossé -12BR Brushed Nickel / Nickel brossé -03 24K Gold Plated / Plaqué or 24K -04 Chrome / Chrome -13 Satin Nickel / Nickel satiné	SPECULAR / SPÉCULAIRE CL Clear / Clair BK Black / Noir

Using LED lamps in shower trims and an Air Tight housing may result in its lifespan decrease. Contrast cannot be held responsible for LED lamps lifespan loss when used in totally enclosed spaces.

L'utilisation d'une lampe à DEL combinée à une garniture de douche et un boîtier étanche à l'air peut contribuer à diminuer la durée de vie de celle-ci. Contrast ne peut être tenue responsable de la diminution de la durée de vie d'une lampe à DEL utilisée en espace clos.

AVAILABLE HOUSINGS / BOÎTIERS DISPONIBLES

SOURCE	REMODEL RÉNOVATEUR	NEW CONSTRUCTION NOUVELLE CONSTRUCTION	CLASSIC NEW CONSTRUCTION (IC) NOUVELLE CONSTRUCTION ISOLÉ (IC) CLASSIQUE
GU10 (LED / DEL)	RE35GU10-10W	NW35GU10-10W	IC35GU10-10W
MR16 (LED / DEL)	RE35MR16-120-10W RE35MR16-277-10W	NW35MR16-120-10W NW35MR16-277-10W	IC35MR16-120-10W IC35MR16-277-10W
MR16 (Halogen / Halogène)	RE35MR16-120-37W RE35MR16-277-37W	NW35MR16-120-50W NW35MR16-277-50W NW35MR16-120D-50W NW35MR16-277D-50W	IC35MR16-120-37W IC35MR16-277-37W IC35MR16-120D-37W IC35MR16-277D-37W

S3450

Low Profile Shower Trim

Garniture de douche mince



Wet locations
Endroits mouillés



ø 3-5/8" (92 mm)



GU10 (LED/DEL)
MR16 (LED/DEL)



MR16 (Halogen/Halogène)



S3450-04
(illustrated / illustrée)
(Lamp not included / Lampe non incluse)

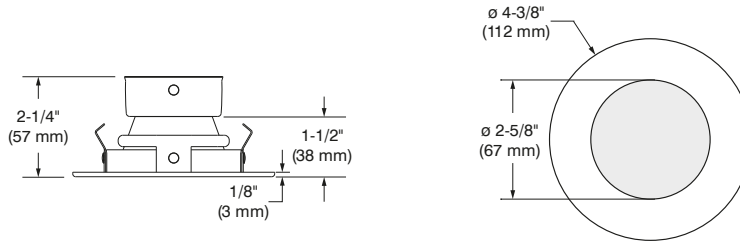

ORDERING CODES / CODES DE COMMANDE

Options in red may result in a longer lead time.
Les options en rouge peuvent générer un délai de production plus long.

MODEL / MODÈLE	LENSES / LENTILLES	TRIM FINISHES / FINIS DE GARNITURE	REFLECTORS / RÉFLECTEURS
S3450			
S3450	Standard : Frosted / Givrée C Clear / Claire FC Frosted with clear center Givrée avec centre clair	POWDER COAT PAINTED RECOUVREMENT EN POUDRE (Standard) White / Blanc Black / Noir -11 Matte White / Blanc mat -22 Matte Black / Noir mat -25 Polar Grey / Gris polaire -05 Architectural Bronze / Bronze architectural -06 Antique Copper / Cuivre antique PLATED / PLAQUÉ (Standard) -04BR Brushed Chrome / Chrome brossé -12BR Brushed Nickel / Nickel brossé -03 24K Gold Plated / Plaqué or 24K -04 Chrome / Chrome -13 Satin Nickel / Nickel satiné	ANODIZED / ANODISÉ Standard : Anodized Aluminum / Aluminium anodisé PAINT / PEINT -01 White / Blanc -02 Black / Noir -11 Matte White / Blanc mat SPECULAR / SPÉCULAIRE CL Clear / Clair BK Black / Noir

Using LED lamps in shower trims and an Air Tight housing may result in its lifespan decrease. Contrast cannot be held responsible for LED lamps lifespan loss when used in totally enclosed spaces.

L'utilisation d'une lampe à DEL combinée à une garniture de douche et un boîtier étanche à l'air peut contribuer à diminuer la durée de vie de celle-ci. Contrast ne peut être tenue responsable de la diminution de la durée de vie d'une lampe à DEL utilisée en espace clos.

AVAILABLE HOUSINGS / BOÎTIERS DISPONIBLES

SOURCE	REMODEL RÉNOVATEUR	NEW CONSTRUCTION NOUVELLE CONSTRUCTION	CLASSIC NEW CONSTRUCTION (IC) NOUVELLE CONSTRUCTION ISOLÉ (IC) CLASSIQUE
GU10 (LED / DEL)	RE35GU10-10W	NW35GU10-10W	IC35GU10-10W
MR16 (LED / DEL)	RE35MR16-120-10W RE35MR16-277-10W	NW35MR16-120-10W NW35MR16-277-10W	IC35MR16-120-10W IC35MR16-277-10W
MR16 (Halogen / Halogène)	RE35MR16-120-37W RE35MR16-277-37W	NW35MR16-120-50W NW35MR16-277-50W NW35MR16-120D-50W NW35MR16-277D-50W	IC35MR16-120-37W IC35MR16-277-37W IC35MR16-120D-37W IC35MR16-277D-37W

3 1/2"

S3450D

Low Profile Adjustable Shower Trim

Garniture de douche orientable mince



Wet locations
Endroits mouillés



ø 3-5/8" (92 mm)



GU10 (LED / DEL)
MR16 (LED / DEL)



MR16 (Halogen / Halogène)



S3450D-13
(illustrated / illustrée)
(Lamp not included / Lampe non incluse)

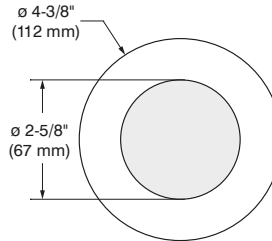
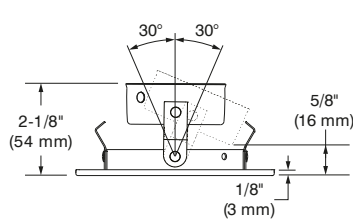

ORDERING CODES / CODES DE COMMANDE

Options in red may result in a longer lead time.
Les options en rouge peuvent générer un délai de production plus long.

MODEL / MODÈLE	LENSES / LENTILLES	TRIM FINISHES / FINIS DE GARNITURE
S3450D		
S3450D	Standard : Frosted / Givrée C Clear / Claire FC Frosted with clear center Givrée avec centre clair	POWDER COAT PAINTED / RECOUVREMENT EN POUDRE (Standard) -01 White / Blanc -02 Black / Noir -11 Matte White / Blanc mat -22 Matte Black / Noir mat -25 Polar Grey / Gris polaire -05 Architectural Bronze / <i>Bronze architectural</i> -06 Antique Copper / <i>Cuivre antique</i>
		PLATED / PLAQUÉ (Standard) -04BR Brushed Chrome / Chrome brossé -12BR Brushed Nickel / Nickel brossé -03 <i>24K Gold Plated / Plaqué or 24K</i> -04 <i>Chrome / Chrome</i> -13 <i>Satin Nickel / Nickel satiné</i>

Using LED lamps in shower trims and an Air Tight housing may result in its lifespan decrease.
Contraste cannot be held responsible for LED lamps lifespan loss when used in totally enclosed spaces.

L'utilisation d'une lampe à DEL combinée à une garniture de douche et un boîtier étanche à l'air peut contribuer à diminuer la durée de vie de celle-ci.
Contraste ne peut être tenue responsable de la diminution de la durée de vie d'une lampe à DEL utilisée en espace clos.

AVAILABLE HOUSINGS / BOÎTIERS DISPONIBLES

SOURCE	REMODEL RÉNOVATEUR	NEW CONSTRUCTION NOUVELLE CONSTRUCTION	CLASSIC NEW CONSTRUCTION (IC) NOUVELLE CONSTRUCTION ISOLÉ (IC) CLASSIQUE
GU10 (LED / DEL)	RE35GU10-10W	NW35GU10-10W	IC35GU10-10W
MR16 (LED / DEL)	RE35MR16-120-10W RE35MR16-277-10W	NW35MR16-120-10W NW35MR16-277-10W	IC35MR16-120-10W IC35MR16-277-10W
MR16 (Halogen / Halogène)	RE35MR16-120-37W RE35MR16-277-37W	NW35MR16-120-50W NW35MR16-277-50W NW35MR16-120D-50W NW35MR16-277D-50W	IC35MR16-120-37W IC35MR16-277-37W IC35MR16-120D-37W IC35MR16-277D-37W



3 1/2"

T3000

Adjustable Regressed Trim

Garniture orientable en retrait



Damp locations
Endroits humides



Ø 3-5/8" (92 mm)



GU10 (LED / DEL)
MR16 (LED / DEL)



MR16 (Halogen / Halogène)



T3000-01
(illustrated / illustrée)
(Lamp not included / Lampe non incluse)

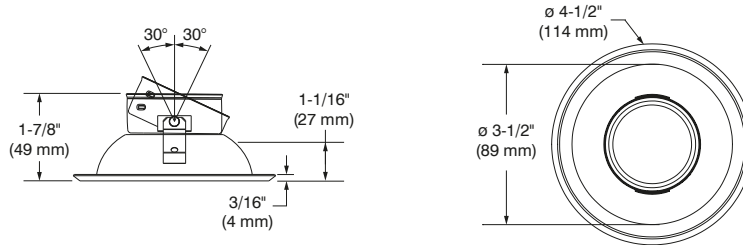

ORDERING CODES / CODES DE COMMANDE

Options in red may result in a longer lead time.
Les options en rouge peuvent générer un délai de production plus long.

MODEL / MODÈLE

TRIM FINISHES / FINIS DE GARNITURE

MODEL / MODÈLE	TRIM FINISHES / FINIS DE GARNITURE
T3000	
T3000	POWDER COAT PAINTED / RECOUVREMENT EN POUDRE (Standard)
-01	White / Blanc
-02	Black / Noir
-11	Matte White / Blanc mat
-22	Matte Black / Noir mat
-25	Polar Grey / Gris polaire
-05	<i>Architectural Bronze / Bronze architectural</i>
-06	<i>Antique Copper / Cuivre antique</i>
	PLATED / PLAQUÉ (Premium)
-04BR	Brushed Chrome / Chrome brossé
-12BR	Brushed Nickel / Nickel brossé
-03	<i>24K Gold Plated / Plaqué or 24K</i>
-04	<i>Chrome / Chrome</i>
-13	<i>Satin Nickel / Nickel satiné</i>

AVAILABLE HOUSINGS / BOÎTIERS DISPONIBLES

SOURCE	REMODEL RÉNOVATEUR	NEW CONSTRUCTION NOUVELLE CONSTRUCTION	CLASSIC NEW CONSTRUCTION (IC) NOUVELLE CONSTRUCTION ISOLÉ (IC) CLASSIQUE
GU10 (LED / DEL)	RE35GU10-10W	NW35GU10-10W	IC35GU10-10W
MR16 (LED / DEL)	RE35MR16-120-10W RE35MR16-277-10W	NW35MR16-120-10W NW35MR16-277-10W	IC35MR16-120-10W IC35MR16-277-10W
MR16 (Halogen / Halogène)	RE35MR16-120-37W RE35MR16-277-37W	NW35MR16-120-50W NW35MR16-277-50W NW35MR16-120D-50W NW35MR16-277D-50W	IC35MR16-120-37W IC35MR16-277-37W IC35MR16-120D-37W IC35MR16-277D-37W

T3100 Square Adjustable Trim

Garniture carrée orientable



Damp locations
Endroits humides



ø 3-5/8" (92 mm)



GU10 (LED / DEL)
MR16 (LED / DEL)



MR16 (Halogen / Halogène)



T3100-12BR
(illustrated / illustrée)
(Lamp not included / Lampe non incluse)

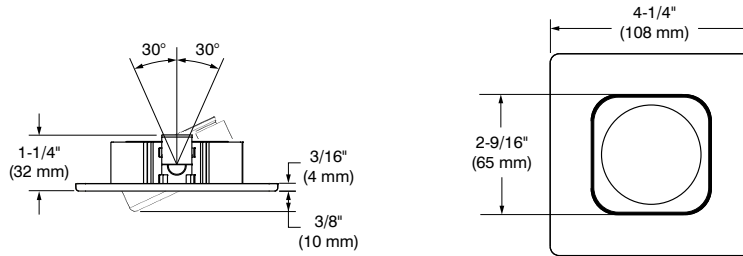

ORDERING CODES / CODES DE COMMANDE

Options in red may result in a longer lead time.
Les options en rouge peuvent générer un délai de production plus long.

MODEL / MODÈLE

TRIM FINISHES / FINIS DE GARNITURE

MODEL / MODÈLE	TRIM FINISHES / FINIS DE GARNITURE
T3100	
T3100	POWDER COAT PAINTED / RECOUVREMENT EN POUDRE (Standard)
	-01 White / Blanc
	-02 Black / Noir
	-11 Matte White / Blanc mat
	-22 Matte Black / Noir mat
	-25 Polar Grey / Gris polaire
	-05 Architectural Bronze / <i>Bronze architectural</i>
	-06 Antique Copper / <i>Cuivre antique</i>
	PLATED / PLAQUÉ (Premium)
	-04BR Brushed Chrome / Chrome brossé
	-12BR Brushed Nickel / Nickel brossé
	-03 <i>24K Gold Plated / Plaqué or 24K</i>
	-04 <i>Chrome / Chrome</i>
	-13 <i>Satin Nickel / Nickel satiné</i>

AVAILABLE HOUSINGS / BOÎTIERS DISPONIBLES

SOURCE	REMODEL RÉNOVATEUR	NEW CONSTRUCTION NOUVELLE CONSTRUCTION	CLASSIC NEW CONSTRUCTION (IC) NOUVELLE CONSTRUCTION ISOLÉ (IC) CLASSIQUE
GU10 (LED / DEL)	RE35GU10-10W	NW35GU10-10W	IC35GU10-10W
MR16 (LED / DEL)	RE35MR16-120-10W RE35MR16-277-10W	NW35MR16-120-10W NW35MR16-277-10W	IC35MR16-120-10W IC35MR16-277-10W
MR16 (Halogen / Halogène)	RE35MR16-120-37W RE35MR16-277-37W	NW35MR16-120-50W NW35MR16-277-50W NW35MR16-120D-50W NW35MR16-277D-50W	IC35MR16-120-37W IC35MR16-277-37W IC35MR16-120D-37W IC35MR16-277D-37W

3 1/2"

T3125

Low Profile Square Adjustable Trim

Garniture carrée orientable mince



Damp locations
Endroits humides



ø 3-5/8" (92 mm)



GU10 (LED / DEL)
MR16 (LED / DEL)



MR16 (Halogen / Halogène)



T3125-03P
(illustrated / illustrée)
(Lamp not included / Lampe non incluse)

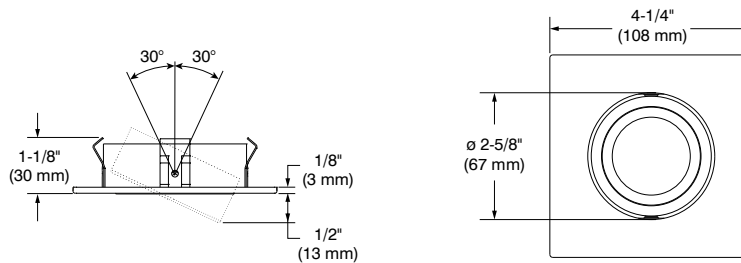

ORDERING CODES / CODES DE COMMANDE

Options in red may result in a longer lead time.
Les options en rouge peuvent générer un délai de production plus long.

MODEL / MODÈLE

TRIM FINISHES / FINIS DE GARNITURE

MODEL / MODÈLE	TRIM FINISHES / FINIS DE GARNITURE
T3125	
T3125	POWDER COAT PAINTED / RECOUVREMENT EN POUDRE (Standard)
-01	White / Blanc
-02	Black / Noir
-11	Matte White / Blanc mat
-22	Matte Black / Noir mat
-25	Polar Grey / Gris polaire
-05	Architectural Bronze / Bronze architectural
-06	Antique Copper / Cuivre antique
	PLATED / PLAQUÉ (Premium)
-04BR	Brushed Chrome / Chrome brossé
-12BR	Brushed Nickel / Nickel brossé
-03P	24K Gold Plated / Plaqué or 24K
-04P	Chrome / Chrome
-13	Satin Nickel / Nickel satiné

AVAILABLE HOUSINGS / BOÎTIERS DISPONIBLES

SOURCE	REMODEL RÉNOVATEUR	NEW CONSTRUCTION NOUVELLE CONSTRUCTION	CLASSIC NEW CONSTRUCTION (IC) NOUVELLE CONSTRUCTION ISOLÉ (IC) CLASSIQUE
GU10 (LED / DEL)	RE35GU10-10W	NW35GU10-10W	IC35GU10-10W
MR16 (LED / DEL)	RE35MR16-120-10W RE35MR16-277-10W	NW35MR16-120-10W NW35MR16-277-10W	IC35MR16-120-10W IC35MR16-277-10W
MR16 (Halogen / Halogène)	RE35MR16-120-37W RE35MR16-277-37W	NW35MR16-120-50W NW35MR16-277-50W NW35MR16-120D-50W NW35MR16-277D-50W	IC35MR16-120-37W IC35MR16-277-37W IC35MR16-120D-37W IC35MR16-277D-37W

T3145

Low Profile Square Regressed Trim Garniture carrée en retrait mince



Damp locations
Endroits humides



ø 3-5/8" (92 mm)



GU10 (LED / DEL)
MR16 (LED / DEL)



MR16 (Halogen / Halogène)



T3145-06
(illustrated / illustrée)
(Lamp not included / Lampe non incluse)

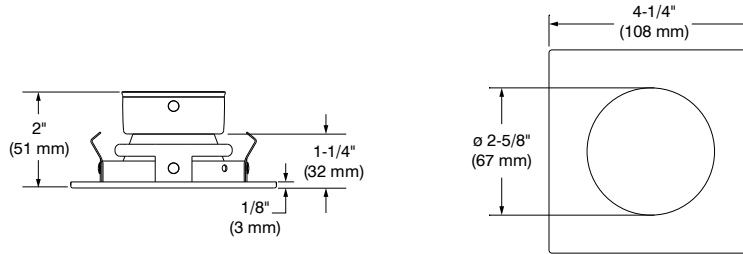

ORDERING CODES / CODES DE COMMANDE

Options in red may result in a longer lead time.
Les options en rouge peuvent générer un délai de production plus long.

MODEL / MODÈLE	TRIM FINISHES / FINIS DE GARNITURE	REFLECTORS / RÉFLECTEURS
T3145	POWDER COAT PAINTED / RECOUVREMENT EN POUDRE (Standard)	ANODIZED / ANODISÉ
T3145	<ul style="list-style-type: none"> -01 White / Blanc -02 Black / Noir -11 Matte White / Blanc mat -22 Matte Black / Noir mat -25 Polar Grey / Gris polaire -05 <i>Architectural Bronze / Bronze architectural</i> -06 <i>Antique Copper / Cuivre antique</i> 	<p>Anodized Aluminum / Aluminium anodisé</p> <p>PAINT / PEINT</p> <ul style="list-style-type: none"> -01 White / Blanc -02 Black / Noir -11 Matte White / Blanc mat
	<p>PLATED / PLAQUÉ (Premium)</p> <ul style="list-style-type: none"> -04BR Brushed Chrome / Chrome brossé -12BR Brushed Nickel / Nickel brossé -03 <i>24K Gold Plated / Plaqué or 24K</i> -04 <i>Chrome / Chrome</i> -13 <i>Satin Nickel / Nickel satiné</i> 	<p>SPECULAR / SPÉCULAIRE</p> <ul style="list-style-type: none"> CL Clear / Clair BK Black / Noir

AVAILABLE HOUSINGS / BOÎTIERS DISPONIBLES

SOURCE	REMODEL RÉNOVATEUR	NEW CONSTRUCTION NOUVELLE CONSTRUCTION	CLASSIC NEW CONSTRUCTION (IC) NOUVELLE CONSTRUCTION ISOLÉ (IC) CLASSIQUE
GU10 (LED / DEL)	RE35GU10-10W	NW35GU10-10W	IC35GU10-10W
MR16 (LED / DEL)	RE35MR16-120-10W RE35MR16-277-10W	NW35MR16-120-10W NW35MR16-277-10W	IC35MR16-120-10W IC35MR16-277-10W
MR16 (Halogen / Halogène)	RE35MR16-120-37W RE35MR16-277-37W	NW35MR16-120-50W NW35MR16-277-50W NW35MR16-120D-50W NW35MR16-277D-50W	IC35MR16-120-37W IC35MR16-277-37W IC35MR16-120D-37W IC35MR16-277D-37W

3 1/2"

T3145D

Low Profile Square Adjustable Regressed Trim

Garniture carrée en retrait orientable mince



Damp locations
Endroits humides



ø 3-5/8" (92 mm)



GU10 (LED / DEL)
MR16 (LED / DEL)



MR16 (Halogen / Halogène)



T3145D-04SM
(illustrated / illustrée)
(Lamp not included / Lampe non incluse)

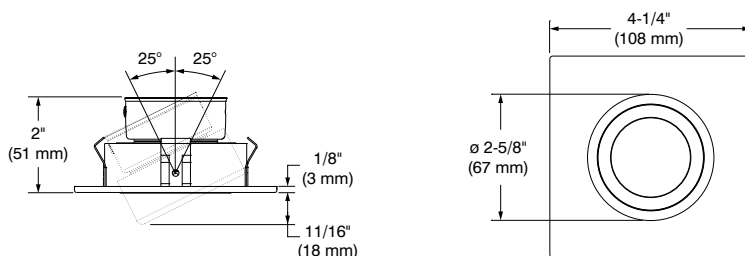

ORDERING CODES / CODES DE COMMANDE

Options in red may result in a longer lead time.
Les options en rouge peuvent générer un délai de production plus long.

MODEL / MODÈLE	TRIM FINISHES / FINIS DE GARNITURE	REFLECTORS / RÉFLECTEURS
T3145D	POWDER COAT PAINTED RECOUVREMENT EN POUDRE (Standard)	ANODIZED / ANODISÉ Standard : Anodized Aluminum / Aluminium anodisé
T3145D	PLATED / PLAQUÉ (Premium)	PAIN / PEINT
	-01 White / Blanc	-01 White / Blanc
	-02 Black / Noir	-02 Black / Noir
	-11 Matte White / Blanc mat	-11 Matte White / Blanc mat
	-22 Matte Black / Noir mat	
	-25 Polar Grey / Gris polaire	
	-05 Architectural Bronze / Bronze architectural	
	-06 Antique Copper / Cuivre antique	
	-04BR Brushed Chrome / Chrome brossé	SPECULAR / SPÉCULAIRE
	-12BR Brushed Nickel / Nickel brossé	CL Clear / Clair
	-03 24K Gold Plated / Plaqué or 24K	BK Black / Noir
	-04 Chrome / Chrome	
	-13 Satin Nickel / Nickel satiné	
		SM Smooth Reflector Réflecteur lisse

AVAILABLE HOUSINGS / BOÎTIERS DISPONIBLES

SOURCE	REMODEL RÉNOVATEUR	NEW CONSTRUCTION NOUVELLE CONSTRUCTION	CLASSIC NEW CONSTRUCTION (IC) NOUVELLE CONSTRUCTION ISOLÉ (IC) CLASSIQUE
GU10 (LED / DEL)	RE35GU10-10W	NW35GU10-10W	IC35GU10-10W
MR16 (LED / DEL)	RE35MR16-120-10W RE35MR16-277-10W	NW35MR16-120-10W NW35MR16-277-10W	IC35MR16-120-10W IC35MR16-277-10W
MR16 (Halogen / Halogène)	RE35MR16-120-37W RE35MR16-277-37W	NW35MR16-120-50W NW35MR16-277-50W NW35MR16-120D-50W NW35MR16-277D-50W	IC35MR16-120-37W IC35MR16-277-37W IC35MR16-120D-37W IC35MR16-277D-37W

T3145DG

Low Profile Square Double Gimbal Trim

Garniture carrée à double orientation mince



Damp locations
Endroits humides



ø 3-5/8" (92 mm)



GU10 (LED / DEL)
MR16 (LED / DEL)



MR16 (Halogen /
Halogène)



T3145DG-13
(illustrated / illustrée)
(Lamp not included / Lampe non incluse)

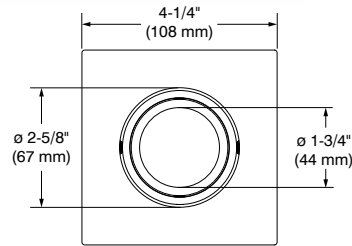
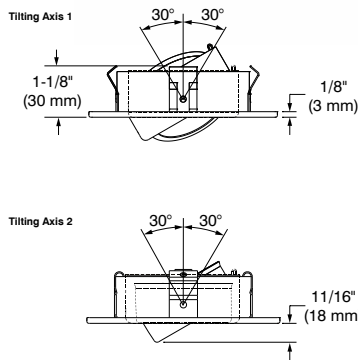

ORDERING CODES / CODES DE COMMANDE

Options in red may result in a longer lead time.
Les options en rouge peuvent générer un délai de production plus long.

MODEL / MODÈLE

TRIM FINISHES / FINIS DE GARNITURE

MODEL / MODÈLE	TRIM FINISHES / FINIS DE GARNITURE
T3145DG	POWDER COAT PAINTED / RECOUVREMENT EN POUDRE
T3145DG	(Standard)
-01	White / Blanc
-02	Black / Noir
-11	Matte White / Blanc mat
-22	Matte Black / Noir mat
-25	Polar Grey / Gris polaire
-05	<i>Architectural Bronze / Bronze architectural</i>
-06	<i>Antique Copper / Cuivre antique</i>
	PLATED / PLAQUÉ
	(Premium)
-04BR	Brushed Chrome / Chrome brossé
-12BR	Brushed Nickel / Nickel brossé
-03	<i>24K Gold Plated / Plaqué or 24K</i>
-04	<i>Chrome / Chrome</i>
-13	<i>Satin Nickel / Nickel satiné</i>

AVAILABLE HOUSINGS / BOÎTIERS DISPONIBLES

SOURCE	REMODEL RÉNOVATEUR	NEW CONSTRUCTION NOUVELLE CONSTRUCTION	CLASSIC NEW CONSTRUCTION (IC) NOUVELLE CONSTRUCTION ISOLÉ (IC) CLASSIQUE
GU10 (LED / DEL)	RE35GU10-10W	NW35GU10-10W	IC35GU10-10W
MR16 (LED / DEL)	RE35MR16-120-10W RE35MR16-277-10W	NW35MR16-120-10W NW35MR16-277-10W	IC35MR16-120-10W IC35MR16-277-10W
MR16 (Halogen / Halogène)	RE35MR16-120-37W RE35MR16-277-37W	NW35MR16-120-50W NW35MR16-277-50W NW35MR16-120D-50W NW35MR16-277D-50W	IC35MR16-120-37W IC35MR16-277-37W IC35MR16-120D-37W IC35MR16-277D-37W

3 1/2"

T3145W

Low Profile Square Regressed Wall Wash Trim

Garniture carrée en retrait mince pour éclairage mural



Damp locations
Endroits humides



ø 3-5/8" (92 mm)



GU10 (LED / DEL)
MR16 (LED / DEL)



MR16 (Halogen / Halogène)



T3145W-11
(illustrated / illustrée)
(Lamp not included / Lampe non incluse)

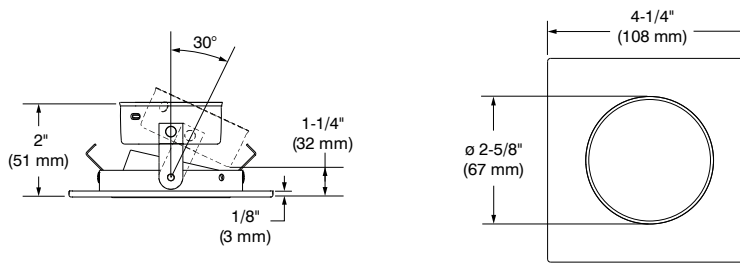

ORDERING CODES / CODES DE COMMANDE

Options in red may result in a longer lead time.
Les options en rouge peuvent générer un délai de production plus long.

MODEL / MODÈLE	TRIM FINISHES / FINIS DE GARNITURE	REFLECTORS / RÉFLECTEURS
T3145W	POWDER COAT PAINTED / RECOUVREMENT EN POUDRE (Standard)	ANODIZED / ANODISÉ
T3145W	<ul style="list-style-type: none"> -01 White / Blanc -02 Black / Noir -11 Matte White / Blanc mat -22 Matte Black / Noir mat -25 Polar Grey / Gris polaire -05 <i>Architectural Bronze / Bronze architecturale</i> -06 <i>Antique Copper / Cuivre antique</i> 	<p>Standard : Anodized Aluminum / Aluminium anodisé</p> <p>PAINT / PEINT</p> <ul style="list-style-type: none"> -01 White / Blanc -02 Black / Noir -11 Matte White / Blanc mat <p>SPECULAR / SPÉCULAIRE</p> <ul style="list-style-type: none"> CL Clear / Clair BK Black / Noir
	<p>PLATED / PLAQUÉ (Premium)</p> <ul style="list-style-type: none"> -04BR Brushed Chrome / Chrome brossé -12BR Brushed Nickel / Nickel brossé -03 <i>24K Gold Plated / Plaqué or 24K</i> -04 <i>Chrome / Chrome</i> -13 <i>Satin Nickel / Nickel satiné</i> 	

AVAILABLE HOUSINGS / BOÎTIERS DISPONIBLES

SOURCE	REMODEL RÉNOVATEUR	NEW CONSTRUCTION NOUVELLE CONSTRUCTION	CLASSIC NEW CONSTRUCTION (IC) NOUVELLE CONSTRUCTION ISOLÉ (IC) CLASSIQUE
GU10 (LED / DEL)	RE35GU10-10W	NW35GU10-10W	IC35GU10-10W
MR16 (LED / DEL)	RE35MR16-120-10W RE35MR16-277-10W	NW35MR16-120-10W NW35MR16-277-10W	IC35MR16-120-10W IC35MR16-277-10W
MR16 (Halogen / Halogène)	RE35MR16-120-37W RE35MR16-277-37W	NW35MR16-120-50W NW35MR16-277-50W NW35MR16-120D-50W NW35MR16-277D-50W	IC35MR16-120-37W IC35MR16-277-37W IC35MR16-120D-37W IC35MR16-277D-37W

T3200

Low Profile Beveled Adjustable Trim

Garniture mince biseautée orientable



Damp locations
Endroits humides



ø 3-5/8" (92 mm)



GU10 (LED / DEL)
MR16 (LED / DEL)



MR16 (Halogen / Halogène)



T3200-22
(illustrated / illustrée)
(Lamp not included / Lampe non incluse)

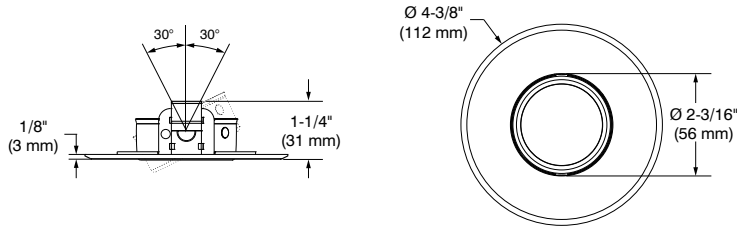

ORDERING CODES / CODES DE COMMANDE

Options in red may result in a longer lead time.
Les options en rouge peuvent générer un délai de production plus long.

MODEL / MODÈLE

TRIM FINISHES / FINIS DE GARNITURE

MODEL / MODÈLE	TRIM FINISHES / FINIS DE GARNITURE
T3200	
T3200	POWDER COAT PAINTED / RECOUVREMENT EN POUVRE (Standard)
-01	White / Blanc
-02	Black / Noir
-11	Matte White / Blanc mat
-22	Matte Black / Noir mat
-25	Polar Grey / Gris polaire
-05	Architectural Bronze / Bronze architectural
-06	Antique Copper / Cuivre antique
	PLATED / PLAQUÉ (Premium)
-04BR	Brushed Chrome / Chrome brossé
-12BR	Brushed Nickel / Nickel brossé
-03	24K Gold Plated / Plaqué or 24K
-04	Chrome / Chrome
-13	Satin Nickel / Nickel satiné

AVAILABLE HOUSINGS / BOÎTIERS DISPONIBLES

SOURCE	REMODEL* RÉNOVATEUR*	NEW CONSTRUCTION NOUVELLE CONSTRUCTION	CLASSIC NEW CONSTRUCTION (IC) NOUVELLE CONSTRUCTION ISOLÉ (IC) CLASSIQUE
GU10 (LED / DEL)	RE35GU10-10W	NW35GU10-10W	IC35GU10-10W
MR16 (LED / DEL)	RE35MR16-120-10W RE35MR16-277-10W	NW35MR16-120-10W NW35MR16-277-10W	IC35MR16-120-10W IC35MR16-277-10W
MR16 (Halogen / Halogène)	RE35MR16-120-37W RE35MR16-277-37W	NW35MR16-120-50W NW35MR16-277-50W NW35MR16-120D-50W NW35MR16-277D-50W	IC35MR16-120-37W IC35MR16-277-37W IC35MR16-120D-37W IC35MR16-277D-37W

T3250

Low Profile Adjustable Trim

Garniture orientable mince



Damp locations
Endroits humides



ø 3-5/8" (92 mm)



GU10 (LED / DEL)
MR16 (LED / DEL)



MR16 (Halogen / Halogène)



T3250-03P
(illustrated / illustrée)
(Lamp not included / Lampe non incluse)

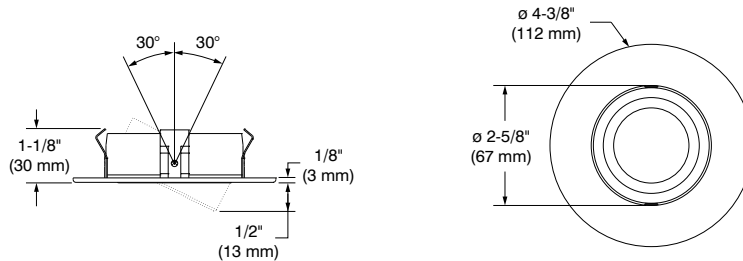

ORDERING CODES / CODES DE COMMANDE

Options in red may result in a longer lead time.
Les options en rouge peuvent générer un délai de production plus long.

MODEL / MODÈLE

TRIM FINISHES / FINIS DE GARNITURE

MODEL / MODÈLE	TRIM FINISHES / FINIS DE GARNITURE
T3250	
T3250	POWDER COAT PAINTED / RECOUVREMENT EN POUDRE (Standard)
-01	White / Blanc
-02	Black / Noir
-11	Matte White / Blanc mat
-22	Matte Black / Noir mat
-25	Polar Grey / Gris polaire
-05	<i>Architectural Bronze / Bronze architectural</i>
-06	<i>Antique Copper / Cuivre antique</i>
	PLATED / PLAQUÉ (Premium)
-04BR	Brushed Chrome / Chrome brossé
-12BR	Brushed Nickel / Nickel brossé
-03	<i>24K Gold Plated / Plaqué or 24K</i>
-04	<i>Chrome / Chrome</i>
-13	<i>Satin Nickel / Nickel satiné</i>

AVAILABLE HOUSINGS / BOÎTIERS DISPONIBLES

SOURCE	REMODEL RÉNOVATEUR	NEW CONSTRUCTION NOUVELLE CONSTRUCTION	CLASSIC NEW CONSTRUCTION (IC) NOUVELLE CONSTRUCTION ISOLÉ (IC) CLASSIQUE
GU10 (LED / DEL)	RE35GU10-10W	NW35GU10-10W	IC35GU10-10W
MR16 (LED / DEL)	RE35MR16-120-10W RE35MR16-277-10W	NW35MR16-120-10W NW35MR16-277-10W	IC35MR16-120-10W IC35MR16-277-10W
MR16 (Halogen / Halogène)	RE35MR16-120-37W RE35MR16-277-37W	NW35MR16-120-50W NW35MR16-277-50W NW35MR16-120D-50W NW35MR16-277D-50W	IC35MR16-120-37W IC35MR16-277-37W IC35MR16-120D-37W IC35MR16-277D-37W

T3450

Low Profile Regressed Trim Garniture en retrait mince



Damp locations
Endroits humides



Ø 3-5/8" (92 mm)



GU10 (LED / DEL)
MR16 (LED / DEL)



MR16 (Halogen / Halogène)



T3450-12BR
(illustrated / illustrée)
(Lamp not included / Lampe non incluse)

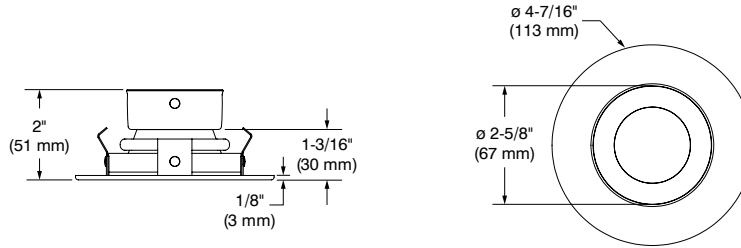

ORDERING CODES / CODES DE COMMANDE

Options in red may result in a longer lead time.
Les options en rouge peuvent générer un délai de production plus long.

MODEL / MODÈLE	TRIM FINISHES / FINIS DE GARNITURE	REFLECTORS / RÉFLECTEURS
T3450	POWDER COAT PAINTED / RECOUVREMENT EN POUVRE (Standard)	ANODIZED / ANODISÉ
T3450	<ul style="list-style-type: none"> -01 White / Blanc -02 Black / Noir -11 Matte White / Blanc mat -22 Matte Black / Noir mat -25 Polar Grey / Gris polaire -05 <i>Architectural Bronze / Bronze architectural</i> -06 <i>Antique Copper / Cuivre antique</i> 	<ul style="list-style-type: none"> Standard : Anodized Aluminum / Aluminium anodisé
	PLATED / PLAQUÉ (Premium)	PAINTE / PEINT
	<ul style="list-style-type: none"> -04BR Brushed Chrome / Chrome brossé -12BR Brushed Nickel / Nickel brossé -03 <i>24K Gold Plated / Plaqué or 24K</i> -04 <i>Chrome / Chrome</i> -13 <i>Satin Nickel / Nickel satiné</i> 	<ul style="list-style-type: none"> -01 White / Blanc -02 Black / Noir -11 Matte White / Blanc mat
		SPECULAR / SPÉCULAIRE
		<ul style="list-style-type: none"> CL Clear / Clair BK Black / Noir

AVAILABLE HOUSINGS / BOÎTIERS DISPONIBLES

SOURCE	REMODEL RÉNOVATEUR	NEW CONSTRUCTION NOUVELLE CONSTRUCTION	CLASSIC NEW CONSTRUCTION (IC) NOUVELLE CONSTRUCTION ISOLÉ (IC) CLASSIQUE
GU10 (LED / DEL)	RE35GU10-10W	NW35GU10-10W	IC35GU10-10W
MR16 (LED / DEL)	RE35MR16-120-10W RE35MR16-277-10W	NW35MR16-120-10W NW35MR16-277-10W	IC35MR16-120-10W IC35MR16-277-10W
MR16 (Halogen / Halogène)	RE35MR16-120-37W RE35MR16-277-37W	NW35MR16-120-50W NW35MR16-277-50W NW35MR16-120D-50W NW35MR16-277D-50W	IC35MR16-120-37W IC35MR16-277-37W IC35MR16-120D-37W IC35MR16-277D-37W



T3450D

Low Profile Regressed Trim with Adjustable Reflector

Garniture en retrait mince avec réflecteur orientable



Damp locations
Endroits humides



ø 3-5/8" (92 mm)



GU10 (LED / DEL)
MR16 (LED / DEL)



MR16 (Halogen / Halogène)



T3450D-25SM
(illustrated / illustrée)
(Lamp not included / Lampe non incluse)

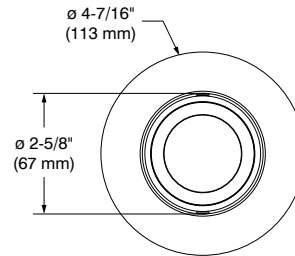
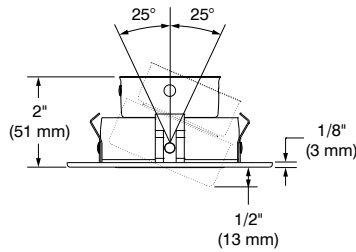

ORDERING CODES / CODES DE COMMANDE

Options in red may result in a longer lead time.
Les options en rouge peuvent générer un délai de production plus long.

MODEL / MODÈLE	TRIM FINISHES / FINIS DE GARNITURE	REFLECTORS / RÉFLECTEURS
T3450D	POWDER COAT PAINTED RECOUVREMENT EN POUDRE (Standard)	ANODIZED / ANODISÉ Standard : Anodized Aluminum / Aluminium anodisé
T3450D	PLATED / PLAQUÉ (Premium)	PAINT / PEINT
	-01 White / Blanc	-01 White / Blanc
	-02 Black / Noir	-02 Black / Noir
	-11 Matte White / Blanc mat	-11 Matte White / Blanc mat
	-22 Matte Black / Noir mat	
	-25 Polar Grey / Gris polaire	
	-05 <i>Architectural Bronze / Bronze architectural</i>	
	-06 <i>Antique Copper / Cuivre antique</i>	
	-04BR Brushed Chrome / Chrome brossé	SPECULAR / SPÉCULAIRE
	-12BR Brushed Nickel / Nickel brossé	-CL Clear / Clair
	-03 <i>24K Gold Plated / Plaqué or 24K</i>	-BK Black / Noir
	-04 <i>Chrome / Chrome</i>	
	-13 <i>Satin Nickel / Nickel satiné</i>	
		SM Smooth Reflector Réflecteur lisse

AVAILABLE HOUSINGS / BOÎTIERS DISPONIBLES

SOURCE	REMODEL RÉNOVATEUR	NEW CONSTRUCTION NOUVELLE CONSTRUCTION	CLASSIC NEW CONSTRUCTION (IC) NOUVELLE CONSTRUCTION ISOLÉ (IC) CLASSIQUE
GU10 (LED / DEL)	RE35GU10-10W	NW35GU10-10W	IC35GU10-10W
MR16 (LED / DEL)	RE35MR16-120-10W RE35MR16-277-10W	NW35MR16-120-10W NW35MR16-277-10W	IC35MR16-120-10W IC35MR16-277-10W
MR16 (Halogen / Halogène)	RE35MR16-120-37W RE35MR16-277-37W	NW35MR16-120-50W NW35MR16-277-50W NW35MR16-120D-50W NW35MR16-277D-50W	IC35MR16-120-37W IC35MR16-277-37W IC35MR16-120D-37W IC35MR16-277D-37W

3 1/2"

T3450W

Low Profile Adjustable Regressed Wall Wash Trim

Garniture orientable en retrait mince pour éclairage mural

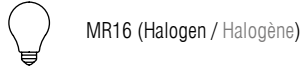
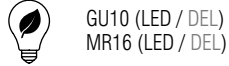
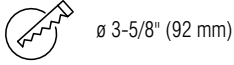

T3450W-13
(illustrated / illustrée)
(Lamp not included / Lampe non incluse)

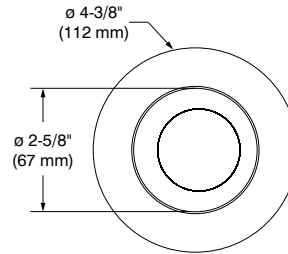
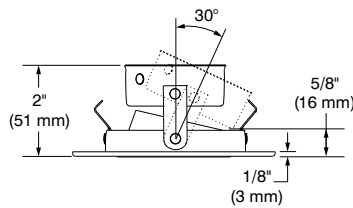

ORDERING CODES / CODES DE COMMANDE

Options in red may result in a longer lead time.
Les options en rouge peuvent générer un délai de production plus long.

MODEL / MODÈLE	TRIM FINISHES / FINIS DE GARNITURE	REFLECTORS / RÉFLECTEURS
T3450W	POWDER COAT PAINTED / RECOUVREMENT EN POUDRE (Standard)	ANODIZED / ANODISÉ
T3450W	<ul style="list-style-type: none"> -01 White / Blanc -02 Black / Noir -11 Matte White / Blanc mat -22 Matte Black / Noir mat -25 Polar Grey / Gris polaire -05 <i>Architectural Bronze / Bronze architecturale</i> -06 <i>Antique Copper / Cuivre antique</i> 	<p>Standard : Anodized Aluminum / Aluminium anodisé</p> <p>PAINT / PEINT</p> <ul style="list-style-type: none"> -01 White / Blanc -02 Black / Noir -11 Matte White / Blanc mat
	<p>PLATED / PLAQUÉ (Premium)</p> <ul style="list-style-type: none"> -04BR Brushed Chrome / Chrome brossé -12BR Brushed Nickel / Nickel brossé -03 <i>24K Gold Plated / Plaqué or 24K</i> -04 <i>Chrome / Chrome</i> -13 <i>Satin Nickel / Nickel satiné</i> 	<p>SPECULAR / SPÉCULAIRE</p> <ul style="list-style-type: none"> CL Clear / Clair BK Black / Noir

AVAILABLE HOUSINGS / BOÎTIERS DISPONIBLES

SOURCE	REMODEL RÉNOVATEUR	NEW CONSTRUCTION NOUVELLE CONSTRUCTION	CLASSIC NEW CONSTRUCTION (IC) NOUVELLE CONSTRUCTION ISOLÉ (IC) CLASSIQUE
GU10 (LED / DEL)	RE35GU10-10W	NW35GU10-10W	IC35GU10-10W
MR16 (LED / DEL)	RE35MR16-120-10W RE35MR16-277-10W	NW35MR16-120-10W NW35MR16-277-10W	IC35MR16-120-10W IC35MR16-277-10W
MR16 (Halogen / Halogène)	RE35MR16-120-37W RE35MR16-277-37W	NW35MR16-120-50W NW35MR16-277-50W NW35MR16-120D-50W NW35MR16-277D-50W	IC35MR16-120-37W IC35MR16-277-37W IC35MR16-120D-37W IC35MR16-277D-37W

T3850

Low Profile Adjustable Regressed Trim with Slot Aperture

Garniture orientable en retrait mince avec ouverture en fente



Damp locations
Endroits humides



ø 3-5/8" (92 mm)



GU10 (LED / DEL)
MR16 (LED / DEL)



MR16 (Halogen / Halogène)



T3850-04
(illustrated / illustrée)
(Lamp not included / Lampe non incluse)

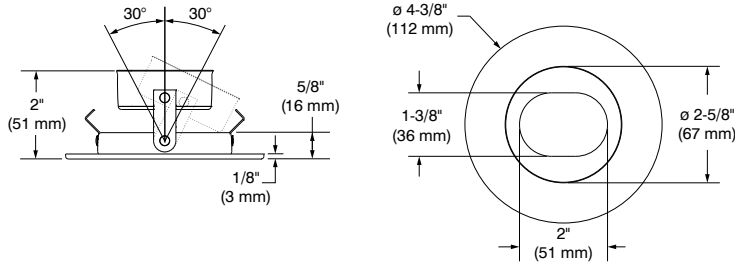

ORDERING CODES / CODES DE COMMANDE

Options in red may result in a longer lead time.
Les options en rouge peuvent générer un délai de production plus long.

MODEL / MODÈLE

TRIM FINISHES / FINIS DE GARNITURE

MODEL / MODÈLE	TRIM FINISHES / FINIS DE GARNITURE
T3850	
T3850	POWDER COAT PAINTED / RECOUVREMENT EN POUVRE (Standard)
-01	White / Blanc
-02	Black / Noir
-11	Matte White / Blanc mat
-22	Matte Black / Noir mat
-25	Polar Grey / Gris polaire
-05	Architectural Bronze / Bronze architectural
-06	Antique Copper / Cuivre antique
	PLATED / PLAQUÉ (Premium)
-04BR	Brushed Chrome / Chrome brossé
-12BR	Brushed Nickel / Nickel brossé
-03	24K Gold Plated / Plaqué or 24K
-04	Chrome / Chrome
-13	Satin Nickel / Nickel satiné

AVAILABLE HOUSINGS / BOÎTIERS DISPONIBLES

SOURCE	REMODEL RÉNOVATEUR	NEW CONSTRUCTION NOUVELLE CONSTRUCTION	CLASSIC NEW CONSTRUCTION (IC) NOUVELLE CONSTRUCTION ISOLÉ (IC) CLASSIQUE
GU10 (LED / DEL)	RE35GU10-10W	NW35GU10-10W	IC35GU10-10W
MR16 (LED / DEL)	RE35MR16-120-10W RE35MR16-277-10W	NW35MR16-120-10W NW35MR16-277-10W	IC35MR16-120-10W IC35MR16-277-10W
MR16 (Halogen / Halogène)	RE35MR16-120-37W RE35MR16-277-37W	NW35MR16-120-50W NW35MR16-277-50W NW35MR16-120D-50W NW35MR16-277D-50W	IC35MR16-120-37W IC35MR16-277-37W IC35MR16-120D-37W IC35MR16-277D-37W

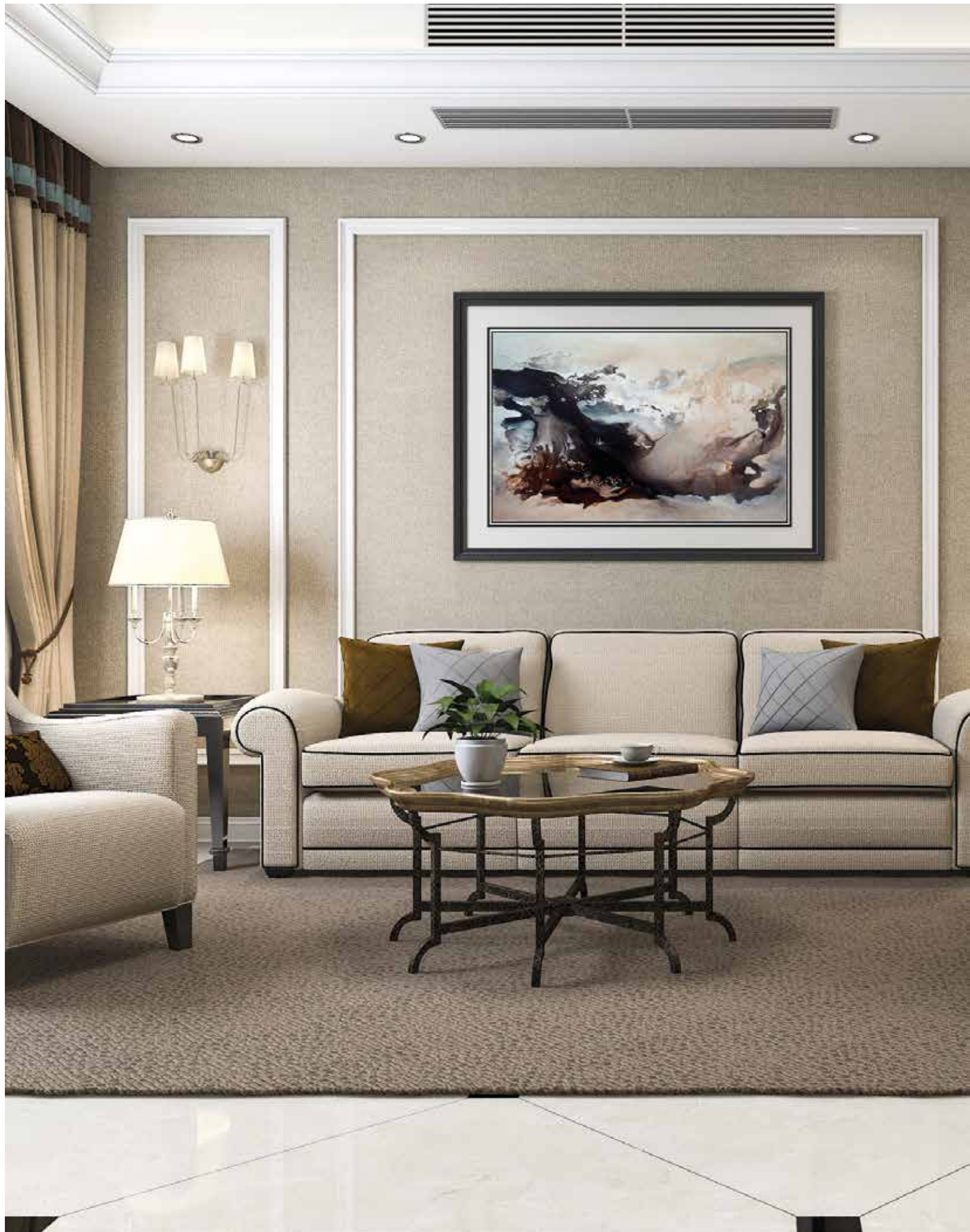

4"



4"

A2000

Low Profile Regressed Trim

Garniture en retrait mince



Damp locations
Endroits humides



ø 4-1/4" (108 mm)



PAR20 (LED / DEL)



A2000-01
(illustrated / illustrée)
(Lamp not included / Lampe non incluse)

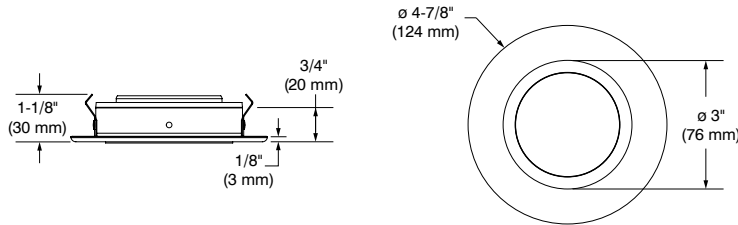

ORDERING CODES / CODES DE COMMANDE

Options in red may result in a longer lead time.
Les options en rouge peuvent générer un délai de production plus long.

MODEL / MODÈLE	TRIM FINISHES / FINIS DE GARNITURE	REFLECTORS / RÉFLECTEURS
A2000	POWDER COAT PAINTED / RECOUVREMENT EN POUDRE (Standard)	Standard: Black semi glossy Standard : Noir semi-lustré
A2000	-01 White / Blanc	
	-02 Black / Noir	W White reflector is available with white trim Réflecteur blanc disponible avec fini blanc
	-11 Matte White / Blanc mat	
	-22 Matte Black / Noir mat	W Matte white reflector is available with matte white trim Réflecteur blanc mat disponible avec fini blanc mat
	-25 Polar Grey / Gris polaire	
	-05 <i>Architectural Bronze / Bronze architecturale</i>	
	-06 <i>Antique Copper / Cuivre antique</i>	
	PLATED / PLAQUÉ (Premium)	
	-04BR Brushed Chrome / Chrome brossé	
	-12BR Brushed Nickel / Nickel brossé	
	-03 <i>24K Gold Plated / Plaqué or 24K</i>	
	-04 <i>Chrome / Chrome</i>	
	-13 <i>Satin Nickel / Nickel satiné</i>	

AVAILABLE HOUSINGS / BOÎTIERS DISPONIBLES

SOURCE	REMODEL RÉNOVATEUR	NEW CONSTRUCTION NOUVELLE CONSTRUCTION	CLASSIC NEW CONSTRUCTION (IC) NOUVELLE CONSTRUCTION ISOLÉ (IC) CLASSIQUE
PAR20 (LED / DEL)	RE40PAR-10W	NW40PAR-10W	IC40PAR-10W

A2100

Low Profile Square Regressed Trim

Garniture carrée en retrait mince



Damp locations
Endroits humides



120V
277V



ø 4-1/4" (108 mm)



PAR20 (LED / DEL)



A2100-04
(illustrated / illustrée)
(Lamp not included / Lampe non incluse)

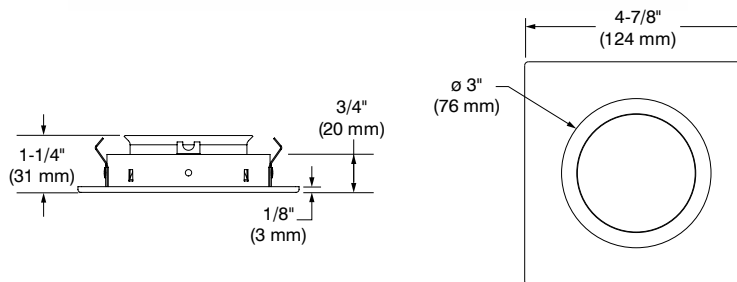

ORDERING CODES / CODES DE COMMANDE

Options in red may result in a longer lead time.
Les options en rouge peuvent générer un délai de production plus long.

MODEL / MODÈLE	TRIM FINISHES / FINIS DE GARNITURE	REFLECTORS / RÉFLECTEURS
A2100	POWDER COAT PAINTED / RECOUVREMENT EN POUDRE (Standard)	Standard: Black semi glossy Standard : Noir semi-lustré
A2100	-01 White / Blanc	W White reflector is available with white trim Réflecteur blanc disponible avec fini blanc
	-02 Black / Noir	W Matte white reflector is available with matte white trim Réflecteur blanc mat disponible avec fini blanc mat
	-11 Matte White / Blanc mat	
	-22 Matte Black / Noir mat	
	-25 Polar Grey / Gris polaire	
	-05 <i>Architectural Bronze / Bronze architecturale</i>	
	-06 <i>Antique Copper / Cuivre antique</i>	
	PLATED / PLAQUÉ (Premium)	
	-04BR Brushed Chrome / Chrome brossé	
	-12BR Brushed Nickel / Nickel brossé	
	-03 <i>24K Gold Plated / Plaqué or 24K</i>	
	-04 <i>Chrome / Chrome</i>	
	-13 <i>Satin Nickel / Nickel satiné</i>	

AVAILABLE HOUSINGS / BOÎTIERS DISPONIBLES

SOURCE	REMODEL RÉNOVATEUR	NEW CONSTRUCTION NOUVELLE CONSTRUCTION	CLASSIC NEW CONSTRUCTION (IC) NOUVELLE CONSTRUCTION ISOLÉ (IC) CLASSIQUE
PAR20 (LED / DEL)	RE40PAR-10W	NW40PAR-10W	IC40PAR-10W

4"

A2450S

Low Profile Shower Trim

Garniture de douche mince

Wet locations
Endroits mouillés

ø 4-1/4" (108 mm)

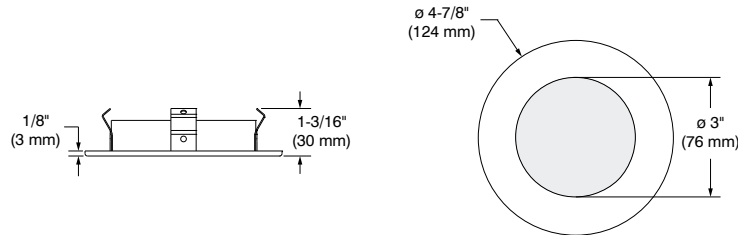

PAR20 (LED / DEL)

**A2450S-05**
(illustrated / illustrée)
(Lamp not included / Lampe non incluse)

ORDERING CODES / CODES DE COMMANDE

Options in red may result in a longer lead time.
Les options en rouge peuvent générer un délai de production plus long.

MODEL / MODÈLE LENS / LENTILLE TRIM FINISHES / FINIS DE GARNITURE

MODEL / MODÈLE	LENS / LENTILLE	TRIM FINISHES / FINIS DE GARNITURE
A2450S		
A2450S	Frosted / Givrée	<p>POWDER COAT PAINTED / RECOUVREMENT EN POUDRE (Standard)</p> <ul style="list-style-type: none"> -01 White / Blanc -02 Black / Noir -11 Matte White / Blanc mat -22 Matte Black / Noir mat -25 Polar Grey / Gris polaire -05 Architectural Bronze / <i>Bronze architectural</i> -06 Antique Copper / <i>Cuivre antique</i> <p>PLATED / PLAQUÉ (Premium)</p> <ul style="list-style-type: none"> -04BR Brushed Chrome / Chrome brossé -12BR Brushed Nickel / Nickel brossé -03 24K Gold Plated / <i>Plaqué or 24K</i> -04 Chrome / <i>Chrome</i> -13 Satin Nickel / <i>Nickel satiné</i>

Using LED lamps in shower trims and an Air Tight housing may result in its lifespan decrease.
Contraste cannot be held responsible for LED lamps lifespan loss when used in totally enclosed spaces.L'utilisation d'une lampe à DEL combinée à une garniture de douche et un boîtier étanche à l'air peut contribuer à diminuer la durée de vie de celle-ci.
Contraste ne peut être tenue responsable de la diminution de la durée de vie d'une lampe à DEL utilisée en espace clos.

AVAILABLE HOUSINGS / BOÎTIERS DISPONIBLES

SOURCE	REMODEL RÉNOVATEUR	NEW CONSTRUCTION NOUVELLE CONSTRUCTION	CLASSIC NEW CONSTRUCTION (IC) NOUVELLE CONSTRUCTION ISOLÉ (IC) CLASSIQUE
PAR20 (LED / DEL)	RE40PAR-10W	NW40PAR-10W	IC40PAR-10W

D2000**Low Profile Adjustable Trim**
Garniture orientable minceDamp locations
Endroits humides

ø 4-1/4" (108 mm)

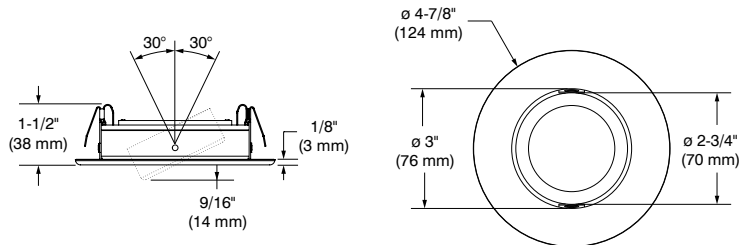

PAR20 (LED / DEL)

**D2000-13**
(illustrated / illustrée)
(Lamp not included / Lampe non incluse)**ORDERING CODES / CODES DE COMMANDE****Options in red may result in a longer lead time.**
*Les options en rouge peuvent générer un délai de production plus long.***MODEL / MODÈLE****TRIM FINISHES / FINIS DE GARNITURE**

D2000	
D2000	POWDER COAT PAINTED / RECOUVREMENT EN POUDRE (Standard)
-01	White / Blanc
-02	Black / Noir
-11	Matte White / Blanc mat
-22	Matte Black / Noir mat
-25	Polar Grey / Gris polaire
-05	Architectural Bronze / Bronze architectural
-06	Antique Copper / Cuivre antique
	PLATED / PLAQUÉ (Premium)
-04BR	Brushed Chrome / Chrome brossé
-12BR	Brushed Nickel / Nickel brossé
-03	24K Gold Plated / Plaqué or 24K
-04	Chrome / Chrome
-13	Satin Nickel / Nickel satiné

AVAILABLE HOUSINGS / BOÎTIERS DISPONIBLES

SOURCE	REMODEL RÉNOVATEUR	NEW CONSTRUCTION NOUVELLE CONSTRUCTION	CLASSIC NEW CONSTRUCTION (IC) NOUVELLE CONSTRUCTION ISOLÉ (IC) CLASSIQUE
PAR20 (LED / DEL)	RE40PAR-10W	NW40PAR-10W	IC40PAR-10W

4"

D2100

Low Profile Square Adjustable Trim

Garniture carrée orientable mince



Damp locations
Endroits humides



Ø 4-1/4" (108 mm)



PAR20 (LED / DEL)



D2100-03P
(illustrated / illustrée)
(Lamp not included / Lampe non incluse)

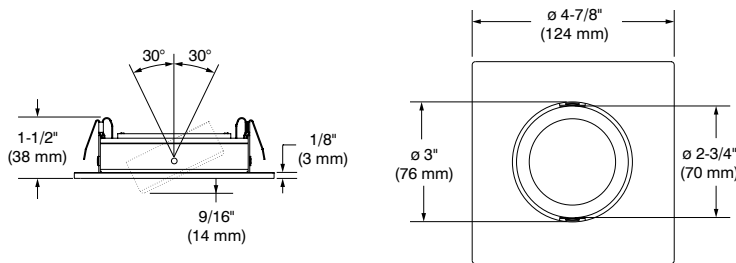

ORDERING CODES / CODES DE COMMANDE

Options in red may result in a longer lead time.
Les options en rouge peuvent générer un délai de production plus long.

MODEL / MODÈLE

TRIM FINISHES / FINIS DE GARNITURE

MODEL / MODÈLE	TRIM FINISHES / FINIS DE GARNITURE
D2100	
D2100	POWDER COAT PAINTED / RECOUVREMENT EN POUDRE (Standard)
-01	White / Blanc
-02	Black / Noir
-11	Matte White / Blanc mat
-22	Matte Black / Noir mat
-25	Polar Grey / Gris polaire
-05	<i>Architectural Bronze / Bronze architectural</i>
-06	<i>Antique Copper / Cuivre antique</i>
	PLATED / PLAQUÉ (Premium)
-04BR	Brushed Chrome / Chrome brossé
-12BR	Brushed Nickel / Nickel brossé
-03P	<i>24K Gold Plated / Plaqué or 24K</i>
-04P	<i>Chrome / Chrome</i>
-13	<i>Satin Nickel / Nickel satiné</i>

AVAILABLE HOUSINGS / BOÎTIERS DISPONIBLES

SOURCE	REMODEL RÉNOVATEUR	NEW CONSTRUCTION NOUVELLE CONSTRUCTION	CLASSIC NEW CONSTRUCTION (IC) NOUVELLE CONSTRUCTION ISOLÉ (IC) CLASSIQUE
PAR20 (LED / DEL)	RE40PAR-10W	NW40PAR-10W	IC40PAR-10W

R2000**Low Profile Adjustable Regressed Trim**

Garniture orientable en retrait mince

Damp locations
Endroits humides

ø 4-1/4" (108 mm)

GU10 (LED / DEL)
MR16 (LED / DEL)

MR16 (Halogen / Halogène)

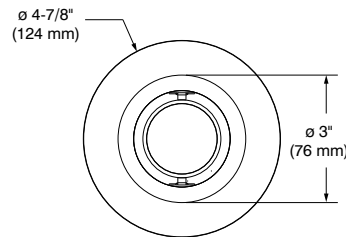
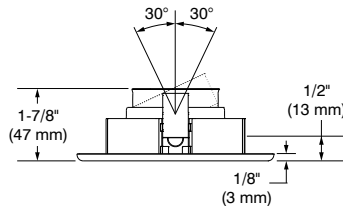
**R2000-06**
(illustrated / illustrée)
(Lamp not included / Lampe non incluse)**ORDERING CODES / CODES DE COMMANDE****Options in red may result in a longer lead time.**
*Les options en rouge peuvent générer un délai de production plus long.***MODEL / MODÈLE****TRIM FINISHES / FINIS DE GARNITURE****REFLECTORS / RÉFLECTEURS**

R2000	POWDER COAT PAINTED / RECOUVREMENT EN POUDRE (Standard)	Standard: Black semi glossy Standard : Noir semi-lustré
R2000	POWDER COAT PAINTED / RECOUVREMENT EN POUDRE (Standard)	
	-01 White / Blanc	S Clear Specular / Spéculaire clair
	-02 Black / Noir	W White reflector is available with white trim Réflecteur blanc disponible avec fini blanc
	-11 Matte White / Blanc mat	W Matte white reflector is available with matte white trim Réflecteur blanc mat disponible avec fini blanc mat
	-22 Matte Black / Noir mat	
	-25 Polar Grey / Gris polaire	
	-05 <i>Architectural Bronze / Bronze architecturale</i>	
	-06 <i>Antique Copper / Cuivre antique</i>	
	PLATED / PLAQUÉ (Premium)	
	-04BR Brushed Chrome / Chrome brossé	
	-12BR Brushed Nickel / Nickel brossé	
	-03 <i>24K Gold Plated / Plaqué or 24K</i>	
	-04 <i>Chrome / Chrome</i>	
	-13 <i>Satin Nickel / Nickel satiné</i>	

AVAILABLE HOUSINGS / BOÎTIERS DISPONIBLES

SOURCE	REMODEL RÉNOVATEUR	NEW CONSTRUCTION NOUVELLE CONSTRUCTION	CLASSIC NEW CONSTRUCTION (IC) NOUVELLE CONSTRUCTION ISOLÉ (IC) CLASSIQUE
GU10 (LED / DEL)	RE40GU10-10W	NW40GU10-10W	IC40GU10-10W
MR16 (LED / DEL)	RE40MR16-120-10W RE40MR16-277-10W	NW40MR16-120-10W NW40MR16-277-10W	IC40MR16-120-10W IC40MR16-277-10W
MR16 (Halogen / Halogène)	RE40MR16-120-37W RE40MR16-277-37W	NW40MR16-120-50W NW40MR16-277-50W NW40MR16-120D-50W NW40MR16-277D-50W	IC40MR16-120-37W IC40MR16-277-37W IC40MR16-120D-37W IC40MR16-277D-37W

4"

R2100**Low Profile Square Adjustable Regressed Trim**

Garniture carrée orientable en retrait mince

Damp locations
Endroits humides

ø 4-1/4" (108 mm)

GU10 (LED / DEL)
MR16 (LED / DEL)

MR16 (Halogen / Halogène)

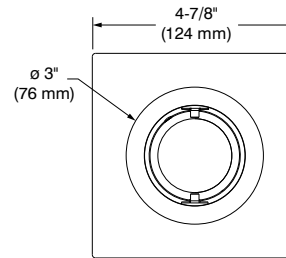
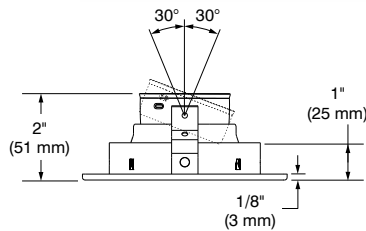
**R2100-04**
(illustrated / illustrée)
(Lamp not included / Lampe non incluse)**ORDERING CODES / CODES DE COMMANDE****Options in red may result in a longer lead time.**
*Les options en rouge peuvent générer un délai de production plus long.***MODEL / MODÈLE****TRIM FINISHES / FINIS DE GARNITURE****REFLECTORS / RÉFLECTEURS**

MODEL / MODÈLE	TRIM FINISHES / FINIS DE GARNITURE	REFLECTORS / RÉFLECTEURS
R2100		
R2100	POWDER COAT PAINTED / RECOUVREMENT EN POUDRE (Standard) -01 White / Blanc -02 Black / Noir -11 Matte White / Blanc mat -22 Matte Black / Noir mat -25 Polar Grey / Gris polaire -05 Architectural Bronze / Bronze architectural -06 Antique Copper / Cuivre antique PLATED / PLAQUÉ (Premium) -04BR Brushed Chrome / Chrome brossé -12BR Brushed Nickel / Nickel brossé -03 24K Gold Plated / Plaqué or 24K -04 Chrome / Chrome -13 Satin Nickel / Nickel satiné	Standard: Black semi glossy Standard : Noir semi-lustré S Clear Specular / Spéculaire clair W White reflector is available with white trim Réflecteur blanc disponible avec fini blanc W Matte white reflector is available with matte white trim Réflecteur blanc mat disponible avec fini blanc mat

AVAILABLE HOUSINGS / BOÎTIERS DISPONIBLES

SOURCE	REMODEL RÉNOVATEUR	NEW CONSTRUCTION NOUVELLE CONSTRUCTION	CLASSIC NEW CONSTRUCTION (IC) NOUVELLE CONSTRUCTION ISOLÉ (IC) CLASSIQUE
GU10 (LED / DEL)	RE40GU10-10W	NW40GU10-10W	IC40GU10-10W
MR16 (LED / DEL)	RE40MR16-120-10W RE40MR16-277-10W	NW40MR16-120-10W NW40MR16-277-10W	IC40MR16-120-10W IC40MR16-277-10W
MR16 (Halogen / Halogène)	RE40MR16-120-37W RE40MR16-277-37W	NW40MR16-120-50W NW40MR16-277-50W NW40MR16-120D-50W NW40MR16-277D-50W	IC40MR16-120-37W IC40MR16-277-37W IC40MR16-120D-37W IC40MR16-277D-37W

S2000

Low Profile Adjustable Shower Trim
Garniture de douche orientable minceWet locations
Endroits mouillés

ø 4-1/4" (108 mm)

GU10 (LED / DEL)
MR16 (LED / DEL)

MR16 (Halogen / Halogène)

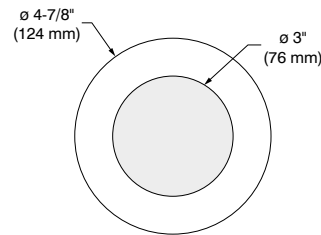
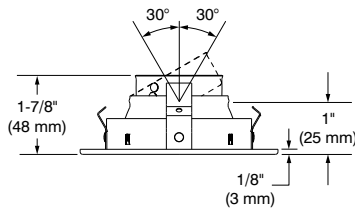
**S2000-11**
(illustrated / illustrée)
(Lamp not included / Lampe non incluse)

ORDERING CODES / CODES DE COMMANDE

Options in red may result in a longer lead time.
Les options en rouge peuvent générer un délai de production plus long.

MODEL / MODÈLE	LENSES / LENTILLES	TRIM FINISHES / FINIS DE GARNITURE
S2000		
S2000	Standard : Frosted / Givrée C Clear / Claire FC Frosted with clear center Givrée avec centre clair	POWDER COAT PAINTED RECOUVREMENT EN POUDRE (Standard) -01 White / Blanc -02 Black / Noir -11 Matte White / Blanc mat -22 Matte Black / Noir mat -25 Polar Grey / Gris polaire -05 Architectural Bronze / Bronze architectural -06 Antique Copper / Cuivre antique PLATED / PLAQUÉ (Standard) -04BR Brushed Chrome / Chrome brossé -12BR Brushed Nickel / Nickel brossé -03 24K Gold Plated / Plaqué or 24K -04 Chrome / Chrome -13 Satin Nickel / Nickel satiné

Using LED lamps in shower trims and an Air Tight housing may result in its lifespan decrease.

Contraste cannot be held responsible for LED lamps lifespan loss when used in totally enclosed spaces.

L'utilisation d'une lampe à DEL combinée à une garniture de douche et un boîtier étanche à l'air peut contribuer à diminuer la durée de vie de celle-ci.

Contraste ne peut être tenue responsable de la diminution de la durée de vie d'une lampe à DEL utilisée en espace clos.

AVAILABLE HOUSINGS / BOÎTIERS DISPONIBLES

SOURCE	REMODEL RÉNOVATEUR	NEW CONSTRUCTION NOUVELLE CONSTRUCTION	CLASSIC NEW CONSTRUCTION (IC) NOUVELLE CONSTRUCTION ISOLÉ (IC) CLASSIQUE
GU10 (LED / DEL)	RE40GU10-10W	NW40GU10-10W	IC40GU10-10W
MR16 (LED / DEL)	RE40MR16-120-10W RE40MR16-277-10W	NW40MR16-120-10W NW40MR16-277-10W	IC40MR16-120-10W IC40MR16-277-10W
MR16 (Halogen / Halogène)	RE40MR16-120-37W RE40MR16-277-37W	NW40MR16-120-50W NW40MR16-277-50W NW40MR16-120D-50W NW40MR16-277D-50W	IC40MR16-120-37W IC40MR16-277-37W IC40MR16-120D-37W IC40MR16-277D-37W

4"

S2100

Low Profile Square Adjustable Shower Trim

Garniture de douche carrée orientable mince



Wet locations
Endroits mouillés



ø 4-1/4" (108 mm)



GU10 (LED / DEL)
MR16 (LED / DEL)



MR16 (Halogen / Halogène)



S2100-05
(illustrated / illustrée)
(Lamp not included / Lampe non incluse)

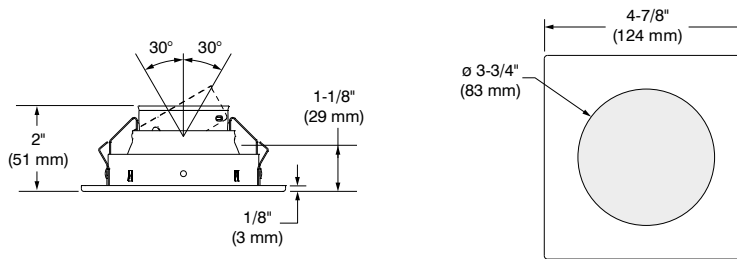

ORDERING CODES / CODES DE COMMANDE

Options in red may result in a longer lead time.
Les options en rouge peuvent générer un délai de production plus long.

MODEL / MODÈLE	LENSES / LENTILLES	TRIM FINISHES / FINIS DE GARNITURE
S2100		
S2100	<p>Standard : Frosted / Givrée</p> <p>C Clear / Claire</p> <p>FC Frosted with clear center Givrée avec centre clair</p>	<p>POWDER COAT PAINTED / RECOUVREMENT EN POUDRE (Standard)</p> <p>-01 White / Blanc</p> <p>-02 Black / Noir</p> <p>-11 Matte White / Blanc mat</p> <p>-22 Matte Black / Noir mat</p> <p>-25 Polar Grey / Gris polaire</p> <p>-05 Architectural Bronze / Bronze architecturale</p> <p>-06 Antique Copper / Cuivre antique</p> <p>PLATED / PLAQUÉ (Standard)</p> <p>-04BR Brushed Chrome / Chrome brossé</p> <p>-12BR Brushed Nickel / Nickel brossé</p> <p>-03 24K Gold Plated / Plaqué or 24K</p> <p>-04 Chrome / Chrome</p> <p>-13 Satin Nickel / Nickel satiné</p>
		<p>Using LED lamps in shower trims and an Air Tight housing may result in its lifespan decrease. Contraste cannot be held responsible for LED lamps lifespan loss when used in totally enclosed spaces.</p> <p>L'utilisation d'une lampe à DEL combinée à une garniture de douche et un boîtier étanche à l'air peut contribuer à diminuer la durée de vie de celle-ci. Contraste ne peut être tenue responsable de la diminution de la durée de vie d'une lampe à DEL utilisée en espace clos.</p>

AVAILABLE HOUSINGS / BOÎTIERS DISPONIBLES

SOURCE	REMODEL RÉNOVATEUR	NEW CONSTRUCTION NOUVELLE CONSTRUCTION	CLASSIC NEW CONSTRUCTION (IC) NOUVELLE CONSTRUCTION ISOLÉ (IC) CLASSIQUE
GU10 (LED / DEL)	RE40GU10-10W	NW40GU10-10W	IC40GU10-10W
MR16 (LED / DEL)	RE40MR16-120-10W RE40MR16-277-10W	NW40MR16-120-10W NW40MR16-277-10W	IC40MR16-120-10W IC40MR16-277-10W
MR16 (Halogen / Halogène)	RE40MR16-120-37W RE40MR16-277-37W	NW40MR16-120-50W NW40MR16-277-50W NW40MR16-120D-50W NW40MR16-277D-50W	IC40MR16-120-37W IC40MR16-277-37W IC40MR16-120D-37W IC40MR16-277D-37W

T2000

Low Profile Adjustable Trim Garniture orientable mince



Damp locations
Endroits humides

120V
277V



ø 4-1/4" (108 mm)



GU10 (LED / DEL)
MR16 (LED / DEL)



MR16 (Halogen / Halogène)



T2000-13
(illustrated / illustrée)
(Lamp not included / Lampe non incluse)

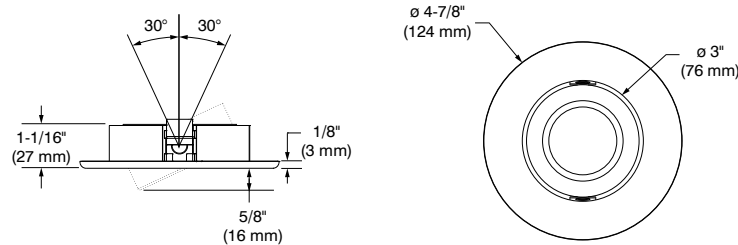

ORDERING CODES / CODES DE COMMANDE

Options in red may result in a longer lead time.
Les options en rouge peuvent générer un délai de production plus long.

MODEL / MODÈLE

TRIM FINISHES / FINIS DE GARNITURE

MODEL / MODÈLE	TRIM FINISHES / FINIS DE GARNITURE
T2000	
T2000	<p>POWDER COAT PAINTED / RECOUVREMENT EN POUDRE <i>(Standard)</i></p> <ul style="list-style-type: none"> -01 White / Blanc -02 Black / Noir -11 Matte White / Blanc mat -22 Matte Black / Noir mat -25 Polar Grey / Gris polaire -05 <i>Architectural Bronze / Bronze architectural</i> -06 <i>Antique Copper / Cuivre antique</i> <p>PLATED / PLAQUÉ <i>(Premium)</i></p> <ul style="list-style-type: none"> -04BR Brushed Chrome / Chrome brossé -12BR Brushed Nickel / Nickel brossé -03 <i>24K Gold Plated / Plaqué or 24K</i> -04 <i>Chrome / Chrome</i> -13 <i>Satin Nickel / Nickel satiné</i>

AVAILABLE HOUSINGS / BOÎTIERS DISPONIBLES

SOURCE	REMODEL RÉNOVATEUR	NEW CONSTRUCTION NOUVELLE CONSTRUCTION	CLASSIC NEW CONSTRUCTION (IC) NOUVELLE CONSTRUCTION ISOLÉ (IC) CLASSIQUE
GU10 (LED / DEL)	RE40GU10-10W	NW40GU10-10W	IC40GU10-10W
MR16 (LED / DEL)	RE40MR16-120-10W RE40MR16-277-10W	NW40MR16-120-10W NW40MR16-277-10W	IC40MR16-120-10W IC40MR16-277-10W
MR16 (Halogen / Halogène)	RE40MR16-120-37W RE40MR16-277-37W	NW40MR16-120-50W NW40MR16-277-50W NW40MR16-120D-50W NW40MR16-277D-50W	IC40MR16-120-37W IC40MR16-277-37W IC40MR16-120D-37W IC40MR16-277D-37W





Accessories

Accessoires

ACCESSORIES / ACCESSOIRES

Lenses / Lentilles

Natural Clear and Frosted Lenses / Lentilles naturelles claires et givrées

For MR16 in 4" (2000) and 3-1/2" (3000) series.
For GU10 in 4" (2000) and 3-1/2" (3000) series.

Pour MR16 dans les séries 4 po (2000) et 3-1/2 po (3000).
Pour GU10 dans les séries 4 po (2000) et 3-1/2 po (3000).



LENSES LENTILLES	MR16 / GU10 (49 mm)	
	3-1/2" (3000 series) and 4" (2000 series) / 3-1/2 po (série 3000) et 4 po (série 2000)	
*Natural Clear / *Naturelle claire	103104	
Natural Frosted / Naturelle givrée	304826	

*This lens is included
Natural Frosted Lens: sold separately

*Cette lentille est incluse
Lentilles naturelles givrées : vendues séparément

Shower Lenses / Lentilles de douche

For MR16, GU10 and PAR20 shower trims.
Pour garnitures de douche MR16, GU10 et PAR20.



LENSES LENTILLES	MR16 (83 mm)	MR16 / GU10 (73 mm)
	4" (2000 series) / 4 po (série 2000)	3-1/2" (3000 series) / 3-1/2 po (série 3000)
Clear / Claire	103108	103105
*Frosted / *Givrée	103109	103189
Frosted clear center / Givrée centre clair	103110	103107

LENSES LENTILLES	PAR20	
	4" (2000 series) / 4 po (série 2000)	
	(83 mm)	(110 mm)
Clear / Claire	103108	103099
*Frosted / *Givrée	103109	103100
Frosted clear center / Givrée centre clair	103110	103101

*This lens is included
The other lens are sold separately

*Cette lentille est incluse
Les autres lentilles sont vendues séparément

Linear, Prismatic and Solite Lenses Lentilles à diffusion linéaire, prismatique et solite

For MR16 in 4" (2000) and 3-1/2" (3000) series.

For GU10 in 4" (2000) and 3-1/2" (3000) series.

MR16 dans les séries 4 po (2000) et 3-1/2 po (3000).

Pour GU10 dans les séries 4 po (2000) et 3-1/2 po (3000).

The linear lens directs the lamp beam to create a strip of light.

The solite lens softens the light in an even overall spread.

The prismatic lens diffuses and spreads the light in an even overall pattern.



La lentille linéaire dirige le faisceau pour créer une bande de lumière.

La lentille solite adoucit et étend uniformément la lumière.

La lentille prismatique diffuse et étend uniformément la lumière.

LENSES LENTILLES	MR16 / GU10 (49 mm)	
	3-1/2" (3000 series) and 4" (2000 series) / 3-1/2 po (série 3000) et 4 po (série 2000)	
Linear / Linéaire	103092	
Solite / Solite	103098	
Prismatic / Prismatique	103095	

These spread lenses are sold separately.

Ces lentilles à diffusion sont vendues séparément.

Honeycomb Lenses / Lentilles hexagonales

For MR16 in 4" (2000) and 3-1/2" (3000) series.

For GU10 in 4" (2000) and 3-1/2" (3000) series.

MR16 dans les séries 4 po (2000) et 3-1/2 po (3000).

Pour GU10 dans les séries 4 po (2000) et 3-1/2 po (3000).

The honeycomb metallic lens reduces glare.

La lentille hexagonale métallique réduit l'éblouissement.

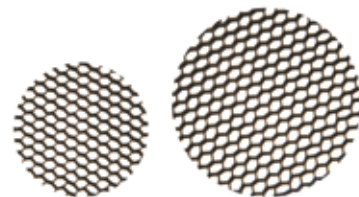

LENS LENTILLE	MR16 / GU10 (49 mm)	
	3-1/2" (3000 series) and 4" (2000 series) / 3-1/2 po (série 3000) et 4 po (série 2000)	
Honeycomb / Hexagonale	103089	

These lenses are sold separately.

Ces lentilles sont vendues séparément.

ACCESSORIES / ACCESSOIRES

Goof Rings / Ronds réparateurs

Goof rings correct the openings too large or damaged ceiling cutout.
Les ronds réparateurs corrigent les ouvertures trop grandes ou abimées des trous de perçage.

Round / Rond

For MR16, GU10 and PAR20 in 4" (2000) and 3-1/2" (3000) series
For PAR30 in 4-3/8" (2575) series

Pour MR16, GU10 et PAR20 dans les séries 4 po (2000) et 3-1/2 po (3000)
Pour PAR30 dans la série 4-3/8 po (2575)



SERIES / SÉRIES	CODE / CODE	DIMENSIONS / DIMENSIONS	
		Outside diameter Diamètre extérieur	Inside diameter Diamètre intérieur
4" (2000 series) / 4 po (série 2000)	RON2000	ø 6-1/8" / ø 6-1/8 po	ø 4-1/8" / ø 4-1/8 po
4-3/8" (2575 series) / 4-3/8 po (série 2575)	RON2575	ø 7" / ø 7 po	ø 4-9/16" / ø 4-9/16 po
3-1/2" (3000 series) / 3-1/2 po (série 3000)	RON3000	ø 6-1/8" / ø 6-1/8 po	ø 3-5/8" / ø 3-5/8 po

Square / Carré

For MR16 and GU10 in 4" (2000) and 3-1/2" (3000) series
Pour MR16 et GU10 dans les séries 4 po (2000) et 3-1/2 po (3000)



SERIES / SÉRIES	CODE / CODE	DIMENSIONS / DIMENSIONS	
		Outside diameter Diamètre extérieur	Inside diameter Diamètre intérieur
4" (2000 series) / 4 po (série 2000)	RON2100	5-1/2" x 5-1/2" / 5-1/2 po x 5-1/2 po	ø 4-1/8" / ø 4-1/8 po
3-1/2" (3000 series) / 3-1/2 po (série 3000)	RON3100	5" x 5" / 5 po x 5 po	ø 3-5/8" / ø 3-5/8 po

All goof rings are available in all Contraste finishes. Add finish color code at the end of the goof rings code.
Ex.: RON2000-15

Les ronds réparateurs sont offerts dans toute la gamme de couleurs Contraste. Ajouter le code du fini désiré à la fin de celui du rond réparateur.
Ex. : RON2000-15

Opening Adaptor / Adaptateur d'ouverture

For round trims of 3-1/2" (3000) series

Pour les granitures rondes de la série 3-1/2 po (3000)

Can lip adaptor for 3-1/2" (89 mm) pot in a 4-1/4" (108 mm) opening.

Finish: galvanized steel

Code: **312296**

Adapte une ouverture allant jusqu'à 4-1/4 (108 mm) pour recevoir un boîtier de 3-1/2 po (89 mm).

Fini : acier galvanisé

Code : **312296**

DIMENSIONS / DIMENSIONS	
Outside diameter Diamètre extérieur	Inside diameter Diamètre intérieur
ø 4-5/16" (110 mm) / ø 4-5/16 po (110 mm)	ø 3-5/8" (92 mm) / ø 3-5/8 po (92 mm)



Vapour Barrier / Coupe-vapeur

Thermoplastic Humidity Protector

Approved for use with CONTRASTE IC Air Tight Remodeler Housings.

Meets UL 1598 Vapor barrier requirements: Rated for 90°C.

Protecteur thermoplastique pour l'humidité

Homologué pour utilisation avec les boîtiers rénovateurs isolés de CONTRASTE.

Conforme à la norme UL 1598 pour les exigences des coupes-vapeur : Testé pour 90°C.

VAPBAR



Vapour Barrier dimensions are:

8-3/4" (222 mm) x 26" (660 mm) x 26" (660 mm)

Code: **VAPBAR**

Les dimensions du coupe-vapeur sont :

8-3/4 po (222 mm) x 26 po (660 mm) x 26 po (660 mm)

Code : **VAPBAR**

VAPBARMEGA

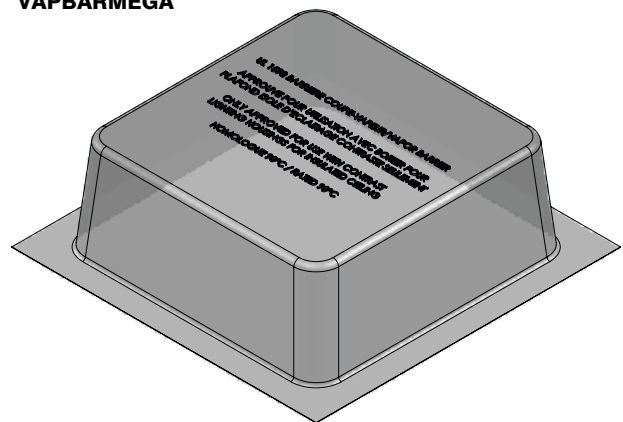

Mega Vapour Barrier dimensions are:

8-1/2" (220 mm) x 27" (690 mm) x 27" (690 mm)

Code: **VAPBARMEGA**

Les dimensions du coupe-vapeur mega sont :

8-1/2 po (220 mm) x 27 po (690 mm) x 27 po (690 mm)

Code : **VAPBARMEGA**

ACCESSORIES / ACCESSOIRES

Reflectors, Baffle and Collar / Réflecteurs, déflecteurs et colerettes

Reflectors and Baffle for 2550 and 2575 Housing Series

Réflecteurs et déflecteurs pour boîtiers des séries 2550 et 2575

SPECULAR REFLECTORS
RÉFLECTEURS SPÉCULAIRES



Black / Noir
REFRE2550-BK
REFRE2575-BK



Clear / Clair
REFRE2550-CL
REFRE2575-CL

PHENOLIC BAFFLES
DÉFLECTEURS PHÉNOLIQUES



White / Blanc
BAFRE2550-01
BAFRE2575-01



Black / Noir
BAFRE2550-02
BAFRE2575-02

Collars for 2550U and 2575 Housing Series

Colerettes pour boîtiers de séries 2550U et 2575

Requires a Reflector (REFRExxxx) or a Baffle (BAFRExxxx). All Contraste finishes are available.

Nécessite un réflecteur (REFRExxxx) ou un déflecteur (BAFRExxxx). Tous les finis Contraste sont offerts.

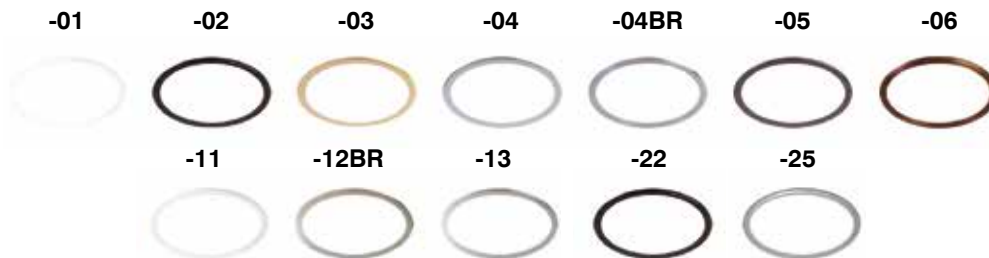

FINISHES FINIS	2550U SERIES SÉRIE 2550U	2575 SERIES SÉRIE 2575
(-01) White / Blanc	C2550-01	C2575-01
(-02) Black / Noir	C2550-02	C2575-02
(-03) 24K Gold Plated / Plaqué or 24K	C2550-03	C2575-03
(-04) Chrome / Chrome	C2550-04	C2575-04
(-04BR) Brushed Chrome / Chrome brossé	C2550-04BR	C2575-04BR
(-05) Architectural Bronze / Bronze architectural	C2550-05	C2575-05
(-06) Antique Cooper / Cuivre antique	C2550-06	C2575-06
(-11) Matte White / Blanc mat	C2550-11	C2575-11
(-12BR) Brushed Nickel / Nickel brossé	C2550-12BR	C2575-12BR
(-13) Satin Nickel / Nickel satiné	C2550-13	C2575-13
(-22) Matte Black / Noir mat	C2550-22	C2575-22
(-25) Polar Grey / Gris polaire	C2550-25	C2575-25

Mounting Plates for Housings / Plaques de montage pour boîtiers

The mounting plates are used to facilitate the installation of the Remodel recessed fixture in a non-drywall ceiling:

- Suspended Ceiling Tiles
- Soffits
- Soft Stretch Ceilings

Les plaques de montage facilitent l'installation du boîtier rénovateur dans les plafonds autres que ceux en placoplâtre (gypse) :

- Tuiles de plafond suspendu
- Retombées de plafond
- Plafond tendu

MOUNTING BARS REQUIRED / BARRES DE MONTAGE REQUISES

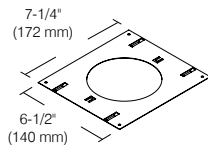

MODEL MODÈLE	SERIES / SÉRIES	CEILING CUTOUT TROU DE PERÇAGE
P2000	4" / 4 po	ø 4-1/4" (108 mm) / ø 4-1/4 po (108 mm)
P2550 / P3600	3-1/2" / 3-1/2 po	ø 3-5/8" (92 mm) / ø 3-5/8 po (92 mm)
P2575 / P2675	4-3/8" / 4-3/8 po	ø 4-5/8" (117 mm) / ø 4-5/8 po (117 mm)

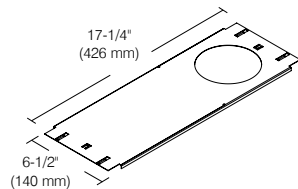

MODEL MODÈLE	SERIES / SÉRIES	CEILING CUTOUT TROU DE PERÇAGE
P2000L	4" / 4 po	ø 4-1/4" (108 mm) / ø 4-1/4 po (108 mm)
P2550L	3-1/2" / 3-1/2 po	ø 3-5/8" (92 mm) / ø 3-5/8 po (92 mm)
P2575L	4-3/8" / 4-3/8 po	ø 4-5/8" (117 mm) / ø 4-5/8 po (117 mm)

MOUNTING BARS NOT REQUIRED / BARRES DE MONTAGE NON REQUISES

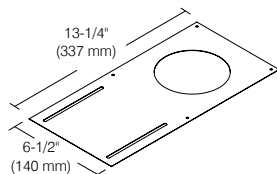

MODEL MODÈLE	SERIES / SÉRIES	CEILING CUTOUT TROU DE PERÇAGE
P2000N	4" / 4 po	ø 4-1/4" (108 mm) / ø 4-1/4 po (108 mm)
P2550N / P3600N	3-1/2" / 3-1/2 po	ø 3-5/8" (92 mm) / ø 3-5/8 po (92 mm)
P2575N / P2675N	4-3/8" / 4-3/8 po	ø 4-5/8" (117 mm) / ø 4-5/8 po (117 mm)

MOUNTING BARS INCLUDED / BARRES DE MONTAGE INCLUSES

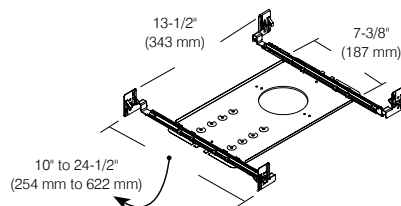

MODEL MODÈLE	SERIES / SÉRIES	CEILING CUTOUT TROU DE PERÇAGE
P2000NW	4" / 4 po	ø 4-1/4" (108 mm) / ø 4-1/4 po (108 mm)
P2550NW	3-1/2" / 3-1/2 po	ø 3-5/8" (92 mm) / ø 3-5/8 po (92 mm)
P2575NW	4-3/8" / 4-3/8 po	ø 4-5/8" (117 mm) / ø 4-5/8 po (117 mm)

ACCESSORIES / ACCESSOIRES

Mounting Bars for Housings / Barres de montage pour boîtiers

ADJUSTABLE MOUNTING BARS / BARRES DE MONTAGE AJUSTABLES

Choose the mounting bars according to the distance in between the joists.

Choisir les barres de montage en fonction de l'espace entre les solives.

Short Bars Adjustable - 2 units / Barres courtes ajustables - 2 unités

BARS From 13-1/2" to 21-3/4" (343 mm to 553 mm) / De 13-1/2 po à 21-3/4 po (343 mm à 553 mm)

Long Bars Adjustable - 2 units / Barres longues ajustables - 2 unités

BARL From 19-1/2" to 34" (495 mm to 863 mm) / De 19-1/2 po à 34 po (495 mm à 863 mm)

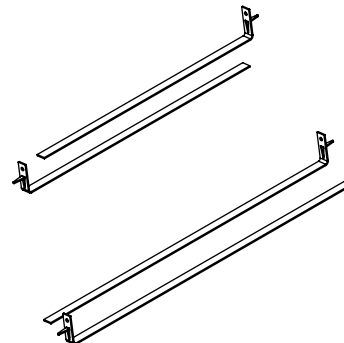

NEW CONSTRUCTION MOUNTING BARS / BARRES DE MONTAGE NOUVELLE CONSTRUCTION

Used in "NW" housings.

Utilisées dans les boîtiers « NW ».

Interlocking Adjustable Bars - 2 pairs Barres ajustables et emboîtables - 2 paires

BARK From 10" to 24-1/2" (254 mm to 622 mm) / De 10 po à 24-1/2 po (254 mm à 622 mm)

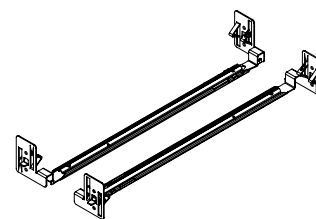

Fire Rated Barrier / Barrière pare-feu

Metallic enclosure, used in ceilings, for all types of recessed Housings IC and Non-IC.

Boîtier métallique, utilisé dans les plafonds, pour tous les types de boîtiers encastrés, isolés et non-isolés.

FRB1



Fire Rated Barrier 1 dimensions are:
20.20" (513 mm) x 12.20" (310 mm) x 9.50" (241 mm)
Code: **FRB1**

Les dimensions de la barrière pare-feu 1 sont :
20,20 po (513 mm) x 12,20 po (310 mm) x 9,50 po (241 mm)
Code : **FRB1**

FRB2



Fire Rated Barrier 2 dimensions are:
20.20" (513 mm) x 12.20" (310 mm) x 6.70" (170 mm)
Code: **FRB2**

Les dimensions de la barrière pare-feu 2 sont :
20,20 po (513 mm) x 12,20 po (310 mm) x 6,70 po (170 mm)
Code : **FRB2**



ELECTRONIC TRANSFORMERS REPLACEMENT KIT ENSEMBLE DE REMPLACEMENT TRANSFORMATEURS ÉLECTRONIQUES

Replacement kits include the transformer and connectors.

Les ensembles de remplacement comprennent le transformateur et les connecteurs.

SOURCE	CODE	HOUSINGS COMPATIBLE WITH THIS REPLACEMENT KIT BOÎTIERS COMPATIBLES AVEC CET ENSEMBLE DE REMPLACEMENT	
MR16 / 120V / ELV / 10W	REP-MR16-120-10W	NW35MR16-120-10W NW40MR16-120-10W	IC35MR16-120-10W IC40MR16-120-10W
MR16 / 120V / ELV / 50W	REP-MR16-120-50W	NW35MR16-120-50W NW40MR16-120-50W	IC35MR16-120-37W IC40MR16-120-37W
MR16 / 277V / ELV / 10W	REP-MR16-277-10W	NW35MR16-277-10W NW40MR16-277-10W	IC35MR16-277-10W IC40MR16-277-10W
MR16 / 277V / ELV / 50W	REP-MR16-277-50W	NW35MR16-277-50W NW40MR16-277-50W	IC35MR16-277-37W IC40MR16-277-37W
MR16 / 120V / 0-10V / 50W	REP-MR16-120D-50W	NW35MR16-120D-50W NW40MR16-120D-50W	IC35MR16-120D-37W IC40MR16-120D-37W
MR16 / 277V / 0-10V / 50W	REP-MR16-277D-50W	NW35MR16-277D-50W NW40MR16-277D-50W	IC35MR16-277D-37W IC40MR16-277D-37W

STEPDOWN AUTOTRANSFORMER / TRANSFORMATEUR ABAISSEUR

Designed for lighting applications to step down main voltage from 347V to 120V

Code: SDT-60M

- Primary Voltage 347V, 60Hz
- Full load secondary output 115V, 60VA
- Class A (105°C) maximum temperature case
- Available with all type of recessed housings IC and Non-IC

Le transformateur abaisseur de CONTRASTE permet de convertir la tension de secteur de 347V à 120V

Code : SDT-60M

- Tension primaire 347V, 60Hz
- Tension secondaire 115V, 60VA
- Isolation Classe A (105°C)
- Disponible avec tous les types de boîtiers encastrés, isolés et non-isolés



CORPORATE HEADQUARTERS

1009, rue du Parc Industriel
Lévis (Québec) G6Z 1C5 Canada

Tel.: 1-888-839-4624
Fax.: 1-877-839-7057

info@contrastlighting.com
contrastlighting.com

© 2021 Contrast Lighting M.L. Inc. All rights reserved
PRINTED IN CANADA

Contrast Lighting reserves the right to make changes in specifications and/or to discontinue any product at any time without notice or obligation and will not be liable for any consequences resulting from the use of this publication.

SIÈGE SOCIAL

1009, rue du Parc Industriel
Lévis (Québec) G6Z 1C5 Canada

Tél. : 1-888-839-4624
Télééc. : 1-877-839-7057

info@contrastlighting.com
eclairagecontraste.com/fr

© 2021 Éclairage Contraste M.L. Inc. Tous droits réservés.
IMPRIMÉ AU CANADA

Éclairage Contraste se réserve le droit de modifier les spécifications et/ou de discontinuer tout produit et en tout temps ne pourra être tenue responsable pour toutes conséquences résultant de l'utilisation de cette publication.

