

ARKOS LIGHT

BY/PAR CONTRASTE



ARKOS LIGHT

BY/PAR

CONTRASTE

A PARTNERSHIP TO LIGHT UP YOUR PROJECTS

Arkos Light, from Spain, and Contraste, from Canada, join forces to bring you the best lighting products into the North American market. Both companies cumulate more than 50 years of lighting manufacturing experience and share the same values – design, quality, performance, and reliability.

If natural light is the best companion for open spaces, we want our luminaires to accompany the spaces created by Man with the same degree of harmony. Architects, lighting designers, interior designers... our raison d'être is to create beauty together.

This catalogue presents the first 6 families that were Americanized. Follow us as more families will be introduced to complete the broad Contraste collection.

UNE ASSOCIATION POUR ÉCLAIRER VOS PROJETS

Arkos Light, de l'Espagne, et Contraste, du Canada, unissent leurs forces pour offrir les meilleurs produits d'éclairage sur le marché nord-américain. Les deux sociétés cumulent plus de 50 années d'expérience dans la fabrication d'éclairage et partagent les mêmes valeurs - la conception, la qualité, la performance et la fiabilité.

Ce catalogue présente les 6 premières familles qui ont été américanisées. Suivez-nous, car plus de familles seront introduites pour compléter la collection Contraste.

Si la lumière naturelle est le meilleur compagnon pour les espaces ouverts, nous voulons que nos luminaires accompagnent les espaces créés par l'homme avec le même degré d'harmonie. Architectes, designers d'éclairage, designers d'intérieur... notre raison d'être est de créer de la beauté ensemble.



TABLE OF CONTENTS

TABLE DES MATIÈRES

4 SALT



Discontinued as of January 1st, 2019
Discontinu  le 1 janvier 2019

10 BRIGIT



Discontinued
(available only while stocks last)
Discontinu 
(disponible jusqu'   puisement de l'inventaire)

14 SLIMGOT



Discontinued
(available only while stocks last)
Discontinu 
(disponible jusqu'   puisement de l'inventaire)

20 DROP



Discontinued as of January 1st, 2019
Discontinu  le 1 janvier 2019

22 STRAM



Discontinued as of January 1st, 2019
Discontinu  le 1 janvier 2019



Save Water
WINE
It's Best To Have
ONE'S
Drink WITH
FRIENDS
I only
DRINK
if I'm
alone WITH
SOMEONE

Discontinued as of January 1st, 2019
Discontinu  le 1 janvier 2019

S
A
L
T

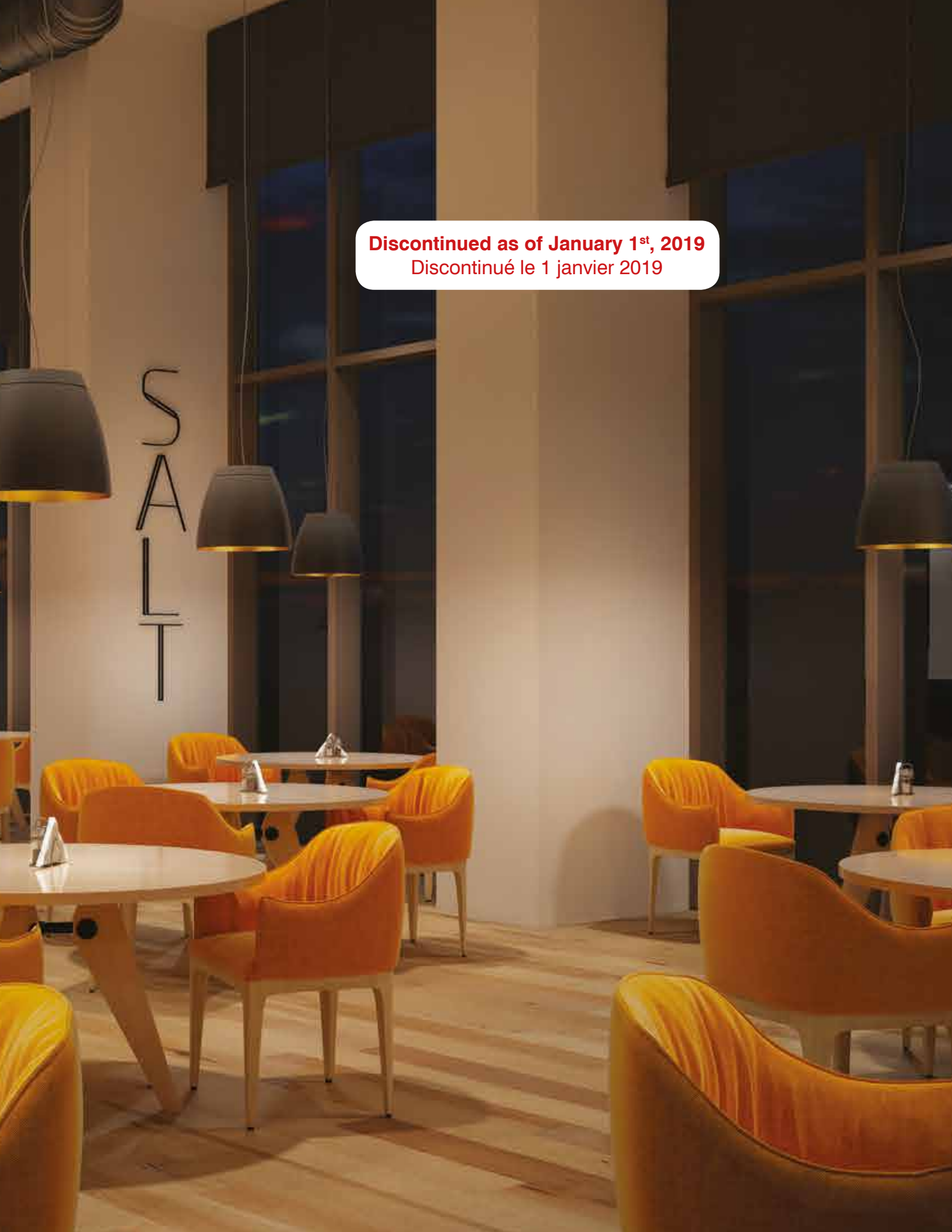

Low Bay light fitting performance combined with the design of a unique decorative piece. Salt integrates driver and heat dissipation into the design of the fitting itself and achieves on the one hand an excellent thermal management and on the other hand the freedom to hang the fixture at any desired height. And to prevent glare, Salt disposes of a diffusor covering the light source.

Les prestations d'un luminaire pour faible hauteur au design typique d'une pièce décorative. Salt intègre pilote et dissipateur thermique directement dans le design du luminaire et permet d'obtenir, d'un côté, une excellente gestion thermique, et de l'autre, la possibilité de régler la hauteur de la cloche à volonté. Salt inclut un diffuseur anti-éblouissement pour sa source lumineuse.



Discontinued as of January 1st, 2019
 Discontinu  le 1 janvier 2019



The Salt PC version with its transparent lampshade emits light also laterally, providing ambient light. Ideal thus also for residential and ample spaces.

Pour la version Salt PC, en plus de l' clairage fixe, cette pi ce  met une lumi re d'ambiance. Id ale pour la maison et pour les grands espaces.



Discontinued as of January 1st, 2019
Discontinu  le 1 janvier 2019



SALT

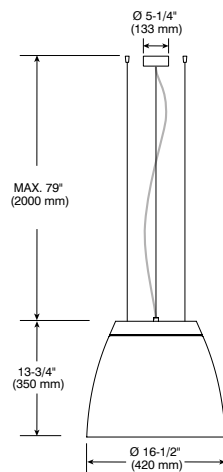

P1-21W 1,600 lm / 1 600 lm
 P2-30W 2,420 lm / 2 420 lm
 P3-39W 3,160 lm / 3 160 lm
 P4-53W 4,260 lm / 4 260 lm
 3,000K / 3 000K
 CRI>90 / IRC>90
 120/277V



LED
DEL



P1 (ELV/0-10V)
 P2 (ELV/0-10V)
 P3 (ELV/0-10V)
 P4 (ELV/0-10V)



6.5'
(2 m)
6.5 pi



FAST
RAPIDE



77°



DAMP
LOCATION
CONVIENT
AUX ENDROITS
HUMIDES

ORDERING CODES for Salt / CODES DE COMMANDE pour Salt

LAMPSHADE ABAT-JOUR	LAMPSHADE COLOR COULEUR DE L'ABAT-JOUR	PERFORMANCE	COLOR TEMPERATURE TEMPERATURE DE COULEUR
SALT			30
SALT	WW White/White Blanc/Blanc	1 1,600 lm / 1 600 lm	30 3,000K / 3 000K
	WG White/Gold Blanc/Or	2 2,420 lm / 2 420 lm	
	WR White/Red Blanc/Rouge	3 3,160 lm / 3 160 lm	
	BW Black/White Noir/Blanc	4 4,260 lm / 4 260 lm	
	BG Black/Gold Noir/Or		
	BR Black/Red Noir/Rouge		

Note: The Red color inside the lampshade has a red-orange tint.
 Note : La couleur rouge   l'int rieur de l'abat-jour est d'une teinte rouge-orang e.



Discontinued as of January 1st, 2019
Discontinu  le 1 janvier 2019



SALT PC

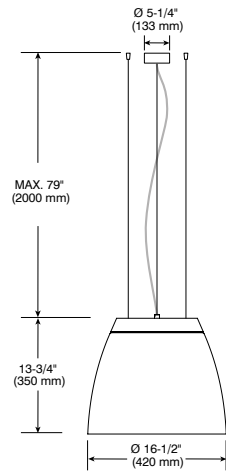

P1-21W 1,960 lm / 1 960 lm
 P2-30W 2,460 lm / 2 460 lm
 P3-39W 3,836 lm / 3 836 lm
 P4-53W 5,170 lm / 5 170 lm
 3,000K / 3 000K
 CRI>90 / IRC>90
 120/277V



LED
DEL



P1 (ELV/0-10V)
 P2 (ELV/0-10V)
 P3 (ELV/0-10V)
 P4 (ELV/0-10V)



6.5'
 (2 m)
 6.5 pi



FAST
RAPIDE



91°



DAMP
LOCATION
CONVIENT
AUX ENDROITS
HUMIDES

ORDERING CODES for Salt PC / CODES DE COMMANDE pour Salt PC

LAMPSHADE ABAT-JOUR	LAMPSHADE COLOR COULEUR DE L'ABAT-JOUR	PERFORMANCE	COLOR TEMPERATURE TEMP�RATURE DE COULEUR
SALT			30
SALT	TW Translucide / White Translucide / Blanc	1 1,960 lm / 1 960 lm	30 3,000K / 3 000K
	TB Translucide / Black Translucide / Noir	2 2,460 lm / 2 460 lm 3 3,836 lm / 3 836 lm 4 5,170 lm / 5 170 lm	



Discontinued
(available only while stocks last)

Discontinué
(disponible jusqu'à épuisement de l'inventaire)

BRIGIT

Brigit is a suspended luminaire with a unique personality. Its distinctive design and different color options make Brigit an ideal option to highlight, with its elegant presence, any interior design space. It combines white downlight lighting with lateral ambient lighting in the color of the chosen shade.

Brigit est un luminaire suspendu avec une personnalité bien à lui. Son design distinctif et ses options de finis de couleur en font une option idéale pour marquer la décoration intérieure des espaces avec sa présence élégante. Brigit combine l'éclairage fixe avec une lumière latérale de la même couleur que la pièce.



Discontinued
(available only while stocks last)
Discontinu 
(disponible jusqu'   puisement de l'inventaire)



BRIGIT WHITE
BRIGIT BLANC



BRIGIT RED
BRIGIT ROUGE



BRIGIT ORANGE
BRIGIT ORANGE

Discontinued
(available only while stocks last)
Discontinué
(disponible jusqu'à épuisement de l'inventaire)

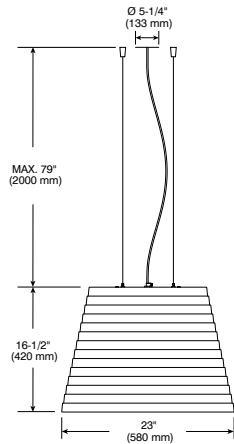

White / Blanc 34W 4,215 lm / 4 215 lm
 Red / Rouge 34W 1,440 lm / 1 440 lm
 Orange / Orange 34W 2,010 lm / 2 010 lm
 3,000K / 3 000K
 CRI>90 / IRC>90
 120/277V



LED
DEL



ELV/0-10V



6.5'
(2 m)
6.5 pi



FAST
RAPIDE



DAMP
LOCATION
CONVIENT
AUX ENDROITS
HUMIDES

ORDERING CODES for Brigit / CODES DE COMMANDE pour Brigit

LAMPSHADE ABAT-JOUR	LAMPSHADE COLOR COULEUR DE L'ABAT-JOUR	DRIVER PILOTE	COLOR TEMPERATURE TEMPÉRATURE DE COULEUR
BRIGIT			30
BRIGIT	W White / Blanc 4,215 lm / 4 215 lm	1 ELV	30 3,000K / 3 000K
	R Red / Rouge 1,440 lm / 1 440 lm	2 Red wire / Fil rouge	
	O Orange / Orange 2,010 lm / 2 010 lm	0-10V	
		Clear wire / Fil clair	

Discontinued
(available only while stocks last)
Discontinu 
(disponible jusqu'   puisement de l'inventaire)

SLIMGOT







SLIMGOT

We present the first suspension that breaks away from the traditional rectangular shape of profiles. Its spirited angles, graceful refinement and bevels give the Slimgot model a unique and exclusive form. Its truncated pyramid geometry optimises light output and gives the fitting a minimalist look and compact size.

Nous présentons le premier luminaire qui rompt avec la traditionnelle forme rectangulaire. Angles vifs, finesse et facettes font de Slimgot un luminaire attirant dès la première impression. Sa géométrie pyramidale tronquée optimise le rendement lumineux et marque par son esthétique minimaliste aux dimensions réduites.

Discontinued
(available only while stocks last)
Discontinué
(disponible jusqu'à épuisement de l'inventaire)



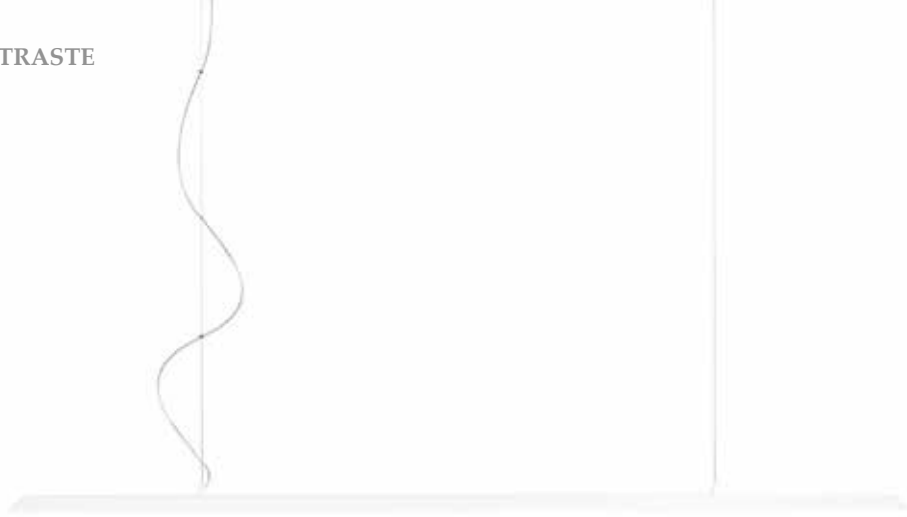

SLIMGOT 120

Discontinued
(available only while stocks last)
Discontinu 
(disponible jusqu'   puisement de l'inventaire)

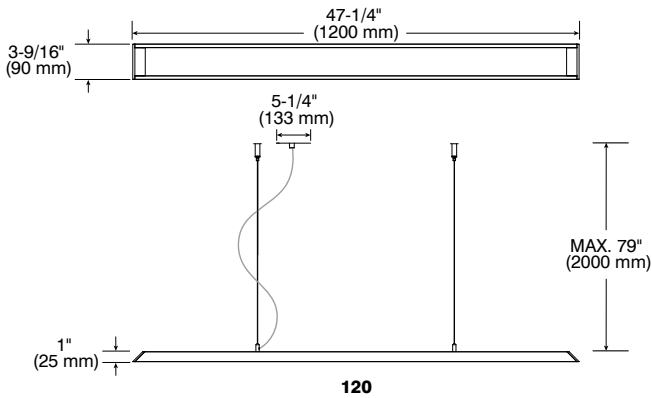

21 W
 2,500 lm / 2 500 lm
 3,000K / 3 000K
 CRI>80 / IRC>80
 120/277V

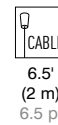

ORDERING CODES for Slimgot 120 / CODES DE COMMANDE pour Slimgot 120

MODEL MOD�LE	SIZE GRANDEUR	COLOR COULEUR	COLOR TEMPERATURE TEMP�RATURE DE COULEUR
SLIMGOT	120	-	30
SLIMGOT	120	W B	30 3,000K / 3 000K
		Matte White / Blanc mat Matte Black / Noir mat	

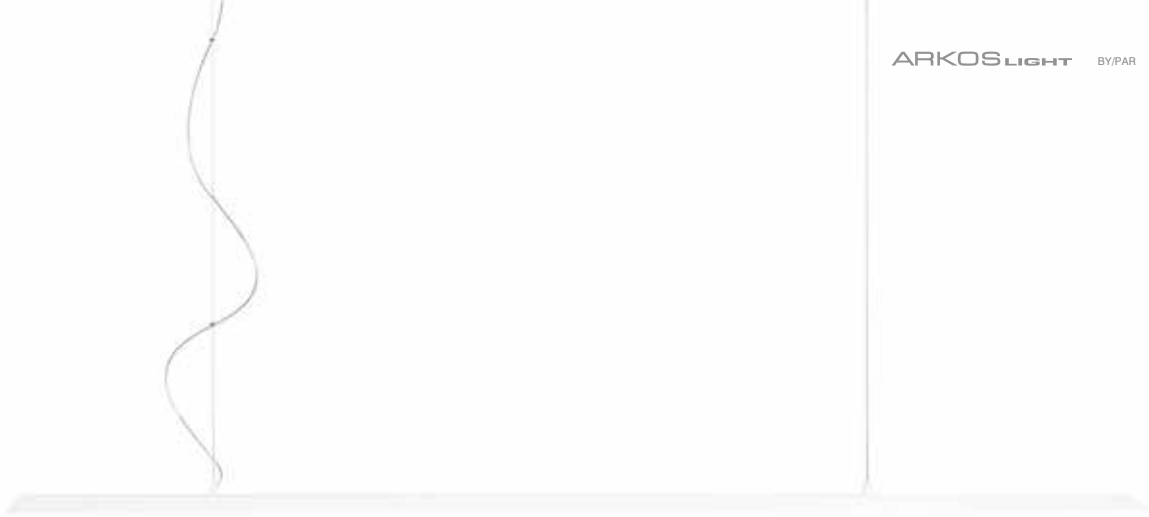

SLIMGOT 150

Discontinued
(available only while stocks last)
Discontinué
(disponible jusqu'à épuisement de l'inventaire)

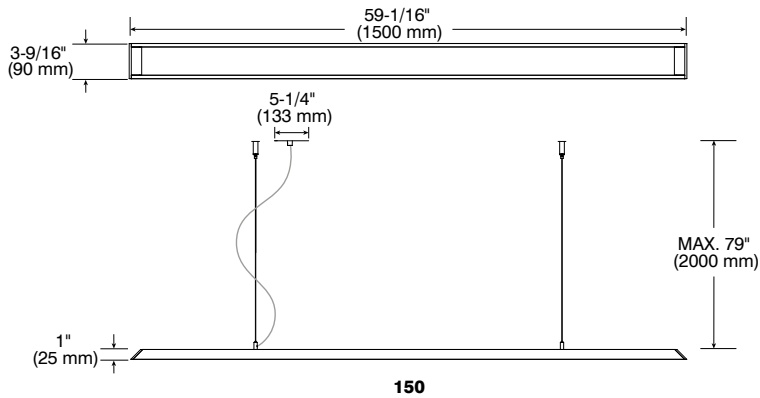

26 W
 3,145 lm / 3 145 lm
 3,000K / 3 000K
 CRI>80 / IRC>80
 120/277V

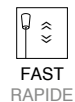
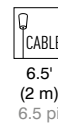

ORDERING CODES for Slimgot 150 / CODES DE COMMANDE pour Slimgot 150

MODEL MODÈLE	SIZE GRANDEUR	COLOR COULEUR	COLOR TEMPERATURE TEMPÉRATURE DE COULEUR
SLIMGOT	150	-	30
SLIMGOT	150	W B	30 3,000K / 3 000K

Discontinued as of January 1st, 2019
Discontinu  le 1 janvier 2019

When lit, the lighting of Drop produces an effect of visually erasing the rims of the fixture, creating the illusion of illumination which resembles that of a natural skylight.

Lorsque allum , l' clairage de Drop produit un effet qui, gr ce   sa clart ,  limine les limites du luminaire. L'effet d' clairage de ce plafonnier est semblable   celui d'une lucarne naturelle.



Discontinued as of January 1st, 2019
Discontinu  le 1 janvier 2019



DROP

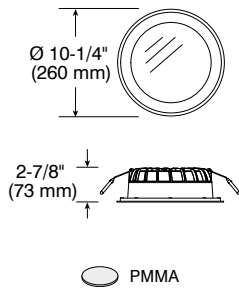

P1-20W 2,040 lm / 2 040 lm
 P2-31W 3,140 lm / 3 140 lm
 P3-39W 3,930 lm / 3 930 lm
 3,000K / 3 000K
 CRI>90 / IRC>90
 UGR 21,7 - 24,9
 120/277V



LED
DEL



100°
 P1 (ELV - 0-10V)
 P2 (ELV - 0-10V)
 P3 (ELV - 0-10V)



100°



Ø 9-5/8"
(245 mm)



DAMP
LOCATION
 CONVIENT
 AUX ENDROITS
 HUMIDES

ORDERING CODES for Drop / CODES DE COMMANDE pour Drop

MODEL MOD�LE	COLOR COULEUR	PERFORMANCE	COLOR TEMPERATURE TEMP�RATURE DE COULEUR
DROP	W Matte White / Blanc mat	1 2,040 lm / 2 040 lm 2 3,140 lm / 3 140 lm 3 3,930 lm / 3 930 lm	30 3,000K / 3 000K

Discontinued as of January 1st, 2019
Discontinu  le 1 janvier 2019

A circular recessed downlight with
the appearance of a surface fixture.
In the Prismatic version, you will discover the attractive
and efficient effect of its diffuser's light waves
which reduce the UGR.

Une garniture fixe encastrable avec collerette, avec
une pr sence marqu e, dans une disposition de stade circulaire
invers . Dans la version Prismatic, d couvrez le c t  attrayant
et l'efficacit  de l'effet d'ondes de lumi re de son diffuseur
qui permet de r duire l'index UGR.



STRAM

Discontinued as of January 1st, 2019
Discontinué le 1 janvier 2019



STRAM





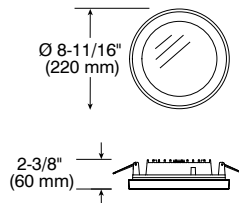

STRAM PRISMATIC





P1-20W 2,040 lm / 2 040 lm
 P2-31W 3,140 lm / 3 140 lm
 P3-39W 3,930 lm / 3 930 lm
 3,000K / 3 000K
 CRI>90 / IRC>90
 UGR 21,2 - 24,5
 120/277V



P1-20W 2,040 lm / 2 040 lm
 P2-31W 3,140 lm / 3 140 lm
 P3-39W 3,930 lm / 3 930 lm
 3,000K / 3 000K
 CRI>90 / IRC>90
 UGR 17,7 - 21
 120/277V

LED DEL P1 (ELV - 0-10V) 103° Ø 8-1/8" (207 mm) DAMP LOCATION CONVIENT AUX ENDROITS HUMIDES
 P2 (ELV - 0-10V)
 P3 (ELV - 0-10V)







LED DEL P1 (ELV - 0-10V) 87° Ø 8-1/8" (207 mm) DAMP LOCATION CONVIENT AUX ENDROITS HUMIDES
 P2 (ELV - 0-10V)
 P3 (ELV - 0-10V)

ORDERING CODES for Stram / CODES DE COMMANDE pour Stram

MODEL MODÈLE	COLOR COULEUR	PERFORMANCE	COLOR TEMPERATURE TEMPÉRATURE DE COULEUR
STRAM			30
STRAM Frosted Lens / Lentille givrée	W Matte White / Blanc mat	1 2,040 lm / 2 040 lm	30 3,000K / 3 000K
STRAMP Prismatic Lens / Lentille prismatique		2 3,140 lm / 3 140 lm	
		3 3,930 lm / 3 930 lm	





ARKOS LIGHT
BY/PAR
CONTRASTE

CORPORATE HEADQUARTERS

1009, rue du Parc Industriel
Lévis (Québec) G6Z 1C5 Canada

Tel.: 1-888-839-4624
Fax.: 1-877-839-7057

info@contrastlighting.com
contrastlighting.com

© 2018 Contrast Lighting M.L. Inc. All rights reserved
PRINTED IN CANADA

Contrast Lighting reserves the right to make changes in specifications and/or to discontinue any product at any time without notice or obligation and will not be liable for any consequences resulting from the use of this publication.

SIÈGE SOCIAL

1009, rue du Parc Industriel
Lévis (Québec) G6Z 1C5 Canada

Tel.: 1-888-839-4624
Télééc.: 1-877-839-7057

info@contrastlighting.com
eclairagecontraste.com/fr

© 2018 Éclairage Contraste M.L. Inc. Tous droits réservés.
IMPRIMÉ AU CANADA

Éclairage Contraste se réserve le droit de modifier les spécifications et/ou de discontinuer tout produit et en tout temps et ne pourra être tenu responsable pour toutes conséquences résultant de l'utilisation de cette publication.

For the latest updates, consult the online version.
Pour les dernières mises à jour, consulter la version en ligne.